



OPEN·HONEST·CONSCIENTIOUS·FAST·PROMISE

Open Group Holding Ltd

PLASTIC ENCLOSURE SERIES
POLYCARBONATE BOX SERIES
METAL ENCLOSURE SERIES

Open Group Holding Ltd

Address: OPEN Building, Liunan Industrial Zone, Liushi Town, Yueqing
City, Zhejiang Province China

Post Code: 325619

TEL: 0086-577-6262 1999

FAX: 0086-577-6273 2105

E-mail: sales@opengroup.cc global-sales@opengroup.cc
salesdirector@opengroup.cc

- <http://www.cn-opengroup.com>
- <http://mcb.en.alibaba.com/>





Plastic Enclosure Series

- 02 - HA Series Of Distribution Box
- 03 - HK Series Of Distribution Box
- 04 - HT Series Of Distribution Box
- 05 - HW Series Of Surface Box
- 06 - TSM-MD/MF Series Of Flush Box
- 07 - TSM-MS Series Of Surface Box
- 08 - NTSM Series Of Flush Box
- 09 - HPK Series Of Surface Box
- 10 - LGD Series Of Flush Box
- 11 - LGD Series Of Surface Box
- 12 - NEW LGD Series Of Flush Box
- 13 - HG I Series Of Distribution Box
- 14 - HG II Series Of Distribution Box
- 15 - HG III Series Of Distribution Box
- 16 - SA Series Of Distribution Box
- 17 - VC Series Of Distribution Box
- 18 - ABC Series Of Distribution Box
- 19 - ZY Series Of Distribution Box
- 20 - NZ Series Of Distribution Box
- 21 - CU Series Of British Distribution Box



Polycarbonate Box Series

- 22 - Combined Socket Distribution Box
- 23 - Portable Socket Distribution Box
- 24 - GU Series Of British Junction Box
- 25 - SKB Series Of Socket Box
- 26 - PJB Series European Junction Box
- 27 - PCB Series Of Plastic Connection Box
- 28 - Switch Box Series
- 30 - Big Box Series
- 32 - Stainless Steel Latch Series
- 33 - Plastic Latch And Hinge Series
- 34 - Lock And Hinge Series
- 35 - TIP Series Polyester Enclosure
- 36 - European-style Waterproof Electric Box
- 37 - CB Series Junction Box
- 38 - Transparent Contact Protection Window Hood
- 39 - General Junction Box



Metal Enclosure Series

- 44 - AR9000 Floor Standing Cabinet
- 46 - Accessories of AR9000 Modular Cabinets
- 48 - AR8000 One Piece Cabinet
- 49 - Accessories of Floor Standing Cabinet
- 52 - Accessories
- 54 - AR6000 Control Desk
- 56 - Wall Mount Enclosure
- 60 - JXF Wall Mounting Metal Cabinets
- 62 - MDB08 3 Phase Metal Distribution Board
- 63 - MED Metal Modular Enclosure
- 64 - Accessories For Wall Mount Enclosure
- 68 - Small Terminal Box TL Series
- 69 - Small Terminal Box TB TBS Series
- 70 - MCU Series Of Metal Consumer Unit
- 71 - TML Series Of Distribution Box
- 72 - MCB BOX
- 73 - Telephone Enclosures And Gland Box
- 74 - Stainless Steel Box with Single Blank Door
- 75 - Stainless Steel With Glazed Door
- 76 - Stainless Steel Box
- 78 - Stainless Steel Box With Single Blank Door
- 79 - Stainless Steel Box With Glazed Door-STPX
- 80 - Aluminum Enclosure
- 81 - OEM And ODM

HA Series Of Distribution Box



General

HA Series lighting box is in line with IEC-493-1 standard, attractive and durable, safe and reliable, which is widely used in various places such as factory, mansion, residence, shopping center and so on.

Features

- ◆ Panel is the ABS material for the engineering, high strength, never change color, the transparent material is PC.
- ◆ Cover push-type opening and closing face covering of the distribution box adopts the push-type opening and closing mode, the face mask can be opened by pressing lightly, the self-locking positioning hinge structure is provided when opening.
- ◆ Wiring design of the power distribution box the guide rail support plate can be lifted to the highest movable point, it is no longer limited by the narrow space when installing the wire. To install easily, the switch of the distribution box is set up with the wire groove and wire pipe exit-holes, which are easy to use for a variety of wire grooves and wire pipes.

Model	Dimensions		
	L(mm)	W(mm)	H(mm)
HA-4P	140	210	100
HA-8P	215	210	100
HA-12P	300	260	140
HA-18P	410	285	140
HA-24P	415	300	140

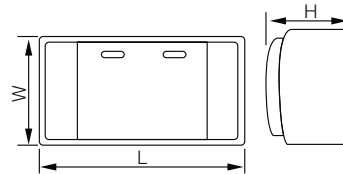

HK Series Of Distribution Box



General

HK Series lighting box is in line with IEC-493-1 standard, attractive and durable, safe and reliable, which is widely used in various places such as factory, mansion, residence, shopping center and so on.

Features

- ◆ Panel is the ABS material for the engineering, high strength, never change color, the transparent material is PC.
- ◆ Cover push-type opening and closing face covering of the distribution box adopts the push-type opening and closing mode, the face mask can be opened by pressing lightly, the self-locking positioning hinge structure is provided when opening.
- ◆ Wiring design of the power distribution box the guide rail support plate can be lifted to the highest movable point, it is no longer limited by the narrow space when installing the wire. To install easily, the switch of the distribution box is set up with the wire groove and wire pipe exit-holes, which are easy to use for a variety of wire grooves and wire pipes.

Model	Dimensions		
	L(mm)	W(mm)	H(mm)
HK2-5P	140	140	105
HK-8P	185	185	105
HK-12P	270	195	105
HK-18P	370	195	105

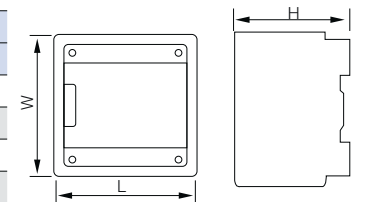

HT Series Of Distribution Box



General

HT Series lighting box is in line with IEC-493-1 standard, attractive and durable, safe and reliable, which is widely used in various places such as factory, mansion, residence, shopping center and so on.

Features

- ◆ Panel is the ABS material for the engineering, high strength, never change color, the transparent material is PC.
- ◆ Cover push-type opening and closing Face covering of the distribution box adopts the push-type opening and closing mode, the face mask can be opened by pressing lightly, the self-locking positioning hinge structure is provided when opening.
- ◆ Wiring design of the power distribution box the guide rail support plate can be lifted to the highest movable point, it is no longer limited by the narrow space when installing the wire. To install easily, the switch of the distribution box is set up with the wire groove and wire pipe exit-holes, which are easy to use for a variety of wire grooves and wire pipes.

Model	Dimensions		
	L(mm)	W(mm)	H(mm)
HT-5P	250	195	70
HT-8P	195	190	55
HT-12P	250	195	70
HT-15P	195	305	70
HT-18P	195	365	70
HT-24P	270	350	70

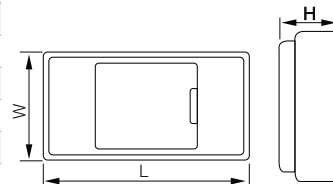

HW Series Of Surface Box



General

The protruding protective layer which is effective in preventing the infiltration of water or dust.

Cover and box body separated.

IP66

With the characteristics of dust & waterproof, Strong hardness, Anti-jamming, Anti-corrosion, Anti-static, radiation proof and so on, it has reached a level of protection IP55.

It's made from High-intensity ABS, PC, refractory Material and UV additive.



Model	Dimensions		
	L(mm)	W(mm)	H(mm)
HW-4P	126	215	100
HW-6P	163	215	100
HW-8P	217	215	100
HW-12P	272	215	100
HW-18P	380	235	100
HW-24P	285	340	100

TSM-MD/MF Series Of Flush Box



Installation dimension of flush mounting type metal distribution box

Model	Dimensions		
	L(mm)	W(mm)	H(mm)
TSM-MD-4P	107	190	85
TSM-MD-6P	143	190	85
TSM-MD-8P	179	190	85
TSM-MD-12P	250	190	85
TSM-MD-15P	306	190	85
TSM-MD-18P	361	217	85
TSM-MD-24P	252	310	85
TSM-MD-36P	290	475	85

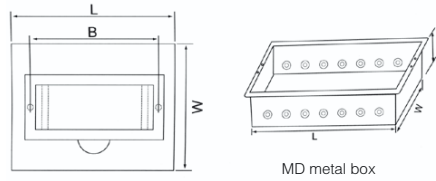

Installation dimension of flush mounting type plastic distribution box

Model	Dimensions		
	L(mm)	W(mm)	H(mm)
TSM-MF-4P	112	200	66
TSM-MF-6P	150	200	66
TSM-MF-8P	184	200	66
TSM-MF-12P	256	200	66
TSM-MF-15P	310	200	66
TSM-MF-18P	365	220	76
TSM-MF-24P	257	310	76
TSM-MF-36P	293	455	76

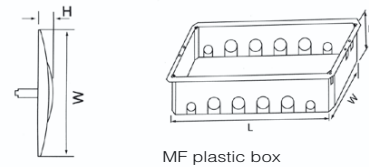

Dimension of plastic cover for flush mounting type distribution box

Model	Dimensions			
	L(mm)	W(mm)	H(mm)	B(mm)
4ways	136	222	27	86
6ways	172	222	27	122
8ways	208	222	27	158
12ways	280	222	27	230
15ways	334	222	27	283
18ways	398	252	27	338
24ways	300	345	27	232
36ways	341	503	27	265

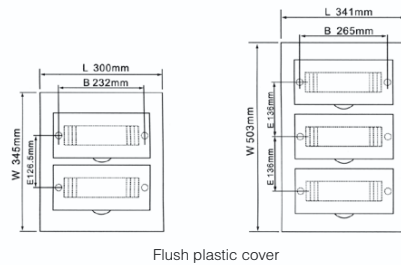

TSM-MS Series Of Surface Box

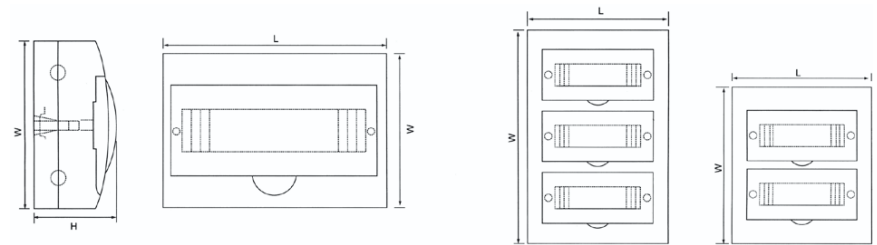

Dimension of surface mounting type plastic distribution box

Model	Dimensions		
	L(mm)	W(mm)	H(mm)
TSM-MS-4P	112	210	100
TSM-MS-6P	148	210	100
TSM-MS-8P	184	210	100
TSM-MS-9P	220	210	100
TSM-MS-10P	220	210	100
TSM-MS-12P	256	210	100
TSM-MS-18P	364	222	100
TSM-MS-24P	270	325	100
TSM-MS-36P	305	473	100



NTSM Series Of Flush Box



General

Overall panel design is luxury and attractive, the face covering colors are dark green and brown (provided according to the color needs of the different interior residential designs except for the standard colors). The design of the face covering gives a noble and elegant feeling. Pure Ivory, high strength, never change color, transparent material is PC. Fixed frame, simple structure, and easy installation.

Plastics Cover Dimension

Model	Dimensions		
	L(mm)	W(mm)	H(mm)
NTSM-4P	150	225	20
NTSM-6P	195	225	20
NTSM-8P	230	225	20
NTSM-12P	300	225	20
NTSM-18P	425	225	20
NTSM-24P	300	345	20

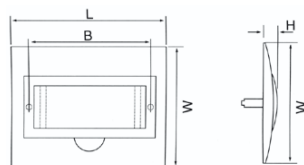

plastics cover

Plastics Base Dimension

Model	Dimensions		
	L(mm)	W(mm)	H(mm)
NTSM-4P	112	200	66
NTSM-6P	150	200	66
NTSM-8P	184	200	66
NTSM-12P	256	200	66
NTSM-18P	365	220	76
NTSM-24P	257	310	76

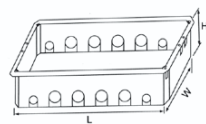

plastics base

HPK Series Of Surface Box



General

This product is made of high flame-retardant ABS plastics, has the advantages of simple installation, safe and practical, good insulation property, impact resistance and so on.

Product structure, The product uses the unique high flexible plastic hinge spring structure, as the turning connection between the perspective panel and overall large panel, which enhances the perspective panel strength and large panel strength, can also quickly open the perspective panel; while it is very easy to open and close the panel due to its clever design, the spring can be able to bounce up the panel by pressing the button lightly. Complete inner ground connection and zero connection terminals, the convergence copper bar can be also used for wiring, easy to use.

Features

- ◆ Rated current: 100 (A)
- ◆ Short-circuit making current: 10 (KA)
- ◆ Shell protection grade: IP45 Shell material: ABS polymeric carbon
- ◆ Face covering: PC

Model	Dimensions		
	L(mm)	W(mm)	H(mm)
HPK-5P	102	145	70
HPK-7P	160	168	75
HPK-10P	220	155	75
HPK-12P	262	168	70
HPK-15P	310	180	70
HPK-18P	355	180	70
HPK-24P	335	270	80

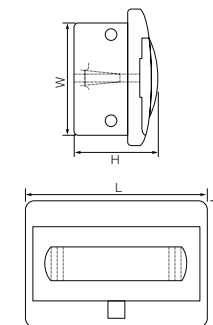

LGD Series Of Flush Box

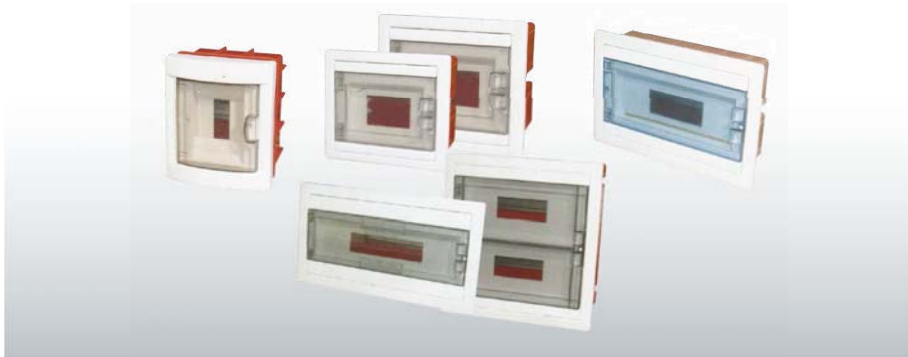

General

LGD Series lighting box is in line with IEC-493-1 standard, attractive and durable, safe and reliable, which is widely used in various places such as factory, mansion, residence, shopping center and so on.

Plastics Base Dimension

Model	Dimensions		
	L(mm)	W(mm)	H(mm)
LGD-3P	115	138	75
LGD-6P	180	155	90
LGD-8P	190	220	90
LGD-12P	298	198	100
LGD-18P	415	212	90
LGD-24P	300	323	90

Case Installation Size

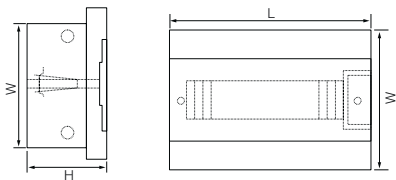

LGD Series Of Surface Box



General

LGD Series lighting box is in line with IEC-493-1 standard, attractive and durable, safe and reliable, which is widely used in various places such as factory, mansion, residence, shopping center and so on.

Plastics Base Dimension

Model	Dimensions		
	L(mm)	W(mm)	H(mm)
LGD-3P	115	138	75
LGD-6P	180	155	90
LGD-8P	190	220	90
LGD-12P	298	198	100
LGD-18P	415	212	90
LGD-24P	300	323	90

Case Installation Size

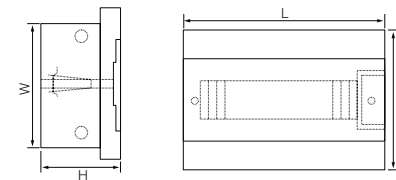

NEW LGD Series Of Flush Box



General

LGD Series lighting box is in line with IEC-493-1 standard, attractive and durable, safe and reliable, which is widely used in various places such as factory, mansion, residence, shopping center and so on.

Plastics Base Dimension

Model	Dimensions		
	L(mm)	W(mm)	H(mm)
LGD-3P	115	138	75
LGD-6P	180	155	90
LGD-8P	190	220	90
LGD-12P	298	198	100
LGD-18P	415	212	90
LGD-24P	300	323	90

Case Installation Size

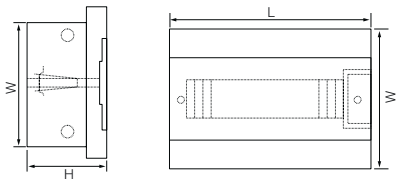

HG I Series Of Distribution Box



General

HG I series of surface box is kind of good-looking outline small volume, easy to install economically modular distribution box. It mainly use for building electric distribution system's installation, matched and house rebuild fitment etc application. The Max rated current is 63A.

Features

◆ Technique parameter

Distribution box rated current:
1 way to 4 way: 50A
6 way to 18 way: 63A

◆ Material: Fire-proof type refractory material

Color: White color
Standard: accord with IEC 060439-3

◆ Protective Degree

IEC60529: IP30
Fire-resistant and anomaly heat ability
IEC60529-1 standard, 650C/30sec

◆ Composition, structure.

Removable matte blocks to increase the poles.

The removable various size holes are available on the box of up and down, bottom in case of connecting wires in and out.

Plastics Box Dimension

Model	Dimensions		
	L(mm)	W(mm)	H(mm)
HG I -1P	34	130	60
HG I -2P	52	130	60
HG I -4P	87	130	60
HG I -6P	125	160	60
HG I -8P	160	160	60
HG I -12P	260	160	60
HG I -18P	365	160	60
HG I -24P	360	250	105

Case Size Installation Of Steel

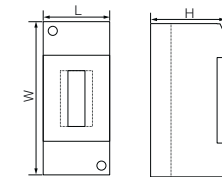

HG II Series Of Distribution Box



General

HG II series of surface box is a kind of good-looking outline small volume. It's easy to install economically modular distribution box. It mainly used for building electric distribution system's installation, matched and house rebuild fitment etc application. The Max rated current is 63A.

Features

- ◆ Technique parameter
Distribution box rated current:
1 way to 4 way: 50A
6 way to 18 way: 63A
- ◆ Material: Fire-proof type refractory material
Color: White color
Standard: accord with IEC 060439-3
- ◆ Protective Degree
IEC60529: IP30
Fire-resistant and anomaly heat ability
IEC60529-1 standard, 650C/30sec
- ◆ Composition, structure.
Removable matte blocks to increase the poles.
The removable various size holes are available on the box of up and down, bottom in case of connecting wires in and out.

Plastics Box Dimension

Model	Dimensions		
	L(mm)	W(mm)	H(mm)
HG II -1P	34	130	60
HG II -2P	52	130	60
HG II -4P	87	130	60
HG II -6P	125	160	60
HG II -8P	160	160	60

Case Size Installation Of Steel

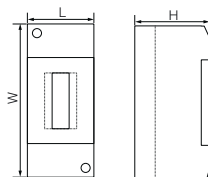

HG III Series Of Distribution Box



General

HG III series of surface box is a kind of good-looking outline small volume. It's easy to install economically modular distribution box. It mainly used for building electric distribution system's installation, matched and house rebuild fitment etc application. The Max rated current is 63A.

Features

- ◆ Technique parameter
Distribution box rated current:
1 way to 4 way: 50A
6 way to 18 way: 63A
- ◆ Material: Fire-proof type refractory material
Color: White color
Standard: accord with IEC 060439-3
- ◆ Protective Degree
IEC60529: IP30
Fire-resistant and anomaly heat ability
IEC60529-1 standard, 650C/30sec
- ◆ Composition, structure.
Removable matte blocks to increase the poles.
The removable various size holes are available on the box of up and down, bottom in case of connecting wires in and out.

Plastics Box Dimension

Model	Dimensions		
	L(mm)	W(mm)	H(mm)
HG III -2P	45	130	80
HG III -4P	90	130	80
HG III -6P	135	130	80
HG III -24P	340	250	95
HG III -36P	465	250	95

Case Size Installation Of Steel

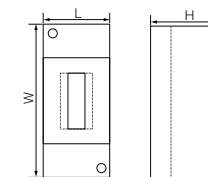

SA Series Of Distribution Box



General

SA Series lighting box is in line with IEC-493-1 standard, attractive and durable, safe and reliable, which is widely used in various places such as factory, mansion, residence, shopping center and so on.

Features

- ◆ Panel is the ABS material for the engineering, high strength, never change color, the transparent material is PC.
- ◆ Cover push-type opening and closing Face covering of the distribution box adopts the push-type opening and closing mode, the face mask can be opened by pressing lightly, the self-locking positioning hinge structure is provided when opening.
- ◆ Wiring design of the power distribution box the guide rail support plate can be lifted to the highest movable point, it is no longer limited by the narrow space when installing the wire. To install easily, the switch of the distribution box is set up with the wire groove and wire pipe exit-holes, which is easy to be used for a variety of wire grooves and wire pipes.

Plastics Base Dimension

Model	Dimensions		
	L(mm)	W(mm)	H(mm)
SA 4+1	112	152	70
SA 8+1	180	150	70
SA 12+1	258	168	70
SA 17+1	370	175	75
SA 24+1	335	270	80

Case Installation Size

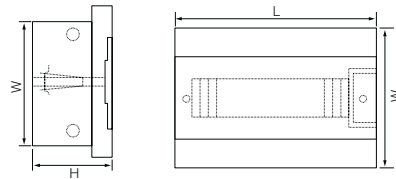

VC Series Of Distribution Box



General

VC Series lighting box is in line with IEC-493-1 standard, attractive and durable, safe and reliable, which is widely used in various places such as factory, mansion, residence, shopping center and so on.

Features

- ◆ Panel is the ABS material for the engineering, high strength, never change color, the transparent material is PC.
- ◆ Cover push-type opening and closing face covering of the distribution box adopts the push-type opening and closing mode, the face mask can be opened by pressing lightly, the self-locking positioning hinge structure is provided when opening.
- ◆ Wiring design of the power distribution box the guide rail support plate can be lifted to the highest movable point, it is no longer limited by the narrow space when installing the wire. To install easily, the switch of the distribution box is set up with the wire groove and wire pipe exit-holes, which is easy to be used for a variety of wire grooves and wire pipes.

Plastics Cover Dimension

Model	Dimensions	
	L(mm)	W(mm)
VC-10	277.5	252
VC-13	331	252
VC-16	382	252
VC-20	452	252



Iron Base Dimension

Model	Dimensions		
	L(mm)	W(mm)	H(mm)
VC-10	247	222	100
VC-13	300	222	100
VC-16	353	222	100
VC-20	422	222	100



ABC Series Of Distribution Box



General

ABC Series lighting box is in line with IEC-493-1 standard, attractive and durable, safe and reliable, which is widely used in various places such as factory, mansion, residence, shopping center and so on.

Features

- ◆ Panel is the ABS material for the engineering, high strength, never change color, the transparent material is PC.
- ◆ Cover push-type opening and closing Face covering of the distribution box adopts the push-type opening and closing mode, the face mask can be opened by pressing lightly, the self-locking positioning hinge structure is provided when opening.
- ◆ Wiring design of the power distribution box The guide rail support plate can be lifted to the highest movable point, it is no longer limited by the narrow space when installing the wire. To install easily, the switch of the distribution box is set up with the wire groove and wire pipe exit-holes, which are easy to use for a variety of wire grooves and wire pipes.

Model	Dimensions		
	L(mm)	W(mm)	H(mm)
ABC-4P	140	210	100
ABC-8P	215	210	100
ABC-12P	300	260	140
ABC-18P	410	285	140
ABC-24P	415	300	140

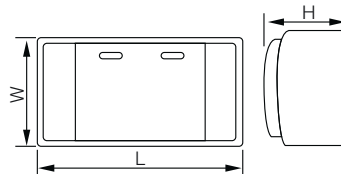

ZY Series Of Distribution Box



General

ZY Series lighting box is in line with IEC-493-1 standard, attractive and durable, safe and reliable, which is widely used in various places such as factory, mansion, residence, shopping center and so on.

Features

- ◆ Panel is the ABS material for the engineering, high strength, never change color, the transparent material is PC.
- ◆ Cover push-type opening and closing face covering of the distribution box adopts the push-type opening and closing mode, the face mask can be opened by pressing lightly, the self-locking positioning hinge structure is provided when opening.
- ◆ Wiring design of the power distribution box the guide rail support plate can be lifted to the highest movable point, it is no longer limited by the narrow space when installing the wire. To install easily, the switch of the distribution box is set up with the wire groove and wire pipe exit-holes, which is easy to be used for a variety of wire grooves and wire pipes.

Plastics Base Dimension

Model	Dimensions		
	L(mm)	W(mm)	H(mm)
ZY-4P	132	142	55
ZY-6(8)P	170	140	55
ZY-10P	212	140	55
ZY-12P	265	160	55
ZY-16P	315	152	55

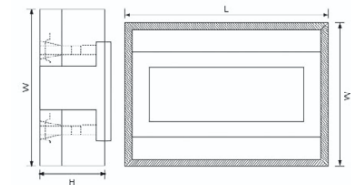

NZ Series Of Distribution Box



General

NZ Series lighting box is in line with IEC-493-1 standard, attractive and durable, safe and reliable, which is widely used in various places such as factory, mansion, residence, shopping center and so on.

Features

- ◆ Panel is the ABS material for the engineering, high strength, never change color, the transparent material is PC.
- ◆ Cover push-type opening and closing face covering of the distribution box adopts the push-type opening and closing mode, the face mask can be opened by pressing lightly, the self-locking positioning hinge structure is provided when opening.
- ◆ Wiring design of the power distribution box the guide rail support plate can be lifted to the highest movable point, it is no longer limited by the narrow space when installing the wire. To install easily, the switch of the distribution box is set up with the wire groove and wire pipe exit-holes, which is easy to be used for a variety of wire grooves and wire pipes.

Plastics Base Dimension

Model	Dimensions		
	L(mm)	W(mm)	H(mm)
NZ-20P	460	360	110
NZ-40P	460	530	110

CU Series Of British Distribution Box



Features

- ◆ With standard of BSEN60439-3
- ◆ 960° UV stop ABS on body and V0 retardant PC on transparent lids.
- ◆ Neutral & Earth terminal link bars assembled
- ◆ Preformed cables or Flexible wires connected on correct terminals
- ◆ Live bus-bar assembled for necessary MCBs fitting
- ◆ With quarter turn plastic screws easy to open and close the front cover
- ◆ IP40 standard suit to indoor use only

Models and Specifications

Model	Part No.	Description
4 Modules	CU4M100	MS 100A + 2 Outgoing ways
	CU4R63	RCD 63A + 2 Outgoing ways
8 Modules	CU8M100	MS 100A + 6 Outgoing ways
	CU8R63	RCD 63A + 6 Outgoing ways
10 Modules	CU10M100	MS 100A + 8 Outgoing ways
	CU10R80	RCD 80A + 8 Outgoing ways
14 Modules	CU10SL10063	MS 100A/RCD 63A Split Load + 6 Outgoing ways
	CU14M100	MS 100A + 12 Outgoing ways
	CU14R80	RCD 80A + 12 Outgoing ways
	CU14SL10063	MS 100A/RCD 63A Split Load + 10 Outgoing ways
	CU14DR10063	MS 100A/2 x RCD 63A + 8 Outgoing ways
18 Modules	CU18M100	MS 100A + 16 Outgoing ways
	CU18R80	RCD 80A + 16 Outgoing ways
	CU18SL10080	MS 100A/RCD 80A Split Load + 14 Outgoing ways
	CU18DR10063	MS 100A/2 x RCD 63A + 12 Outgoing ways
	CU18RRM10063	MS 100A + 2 RCBO Outgoing /2 x RCD 63A+10 Outgoing ways
21 Modules	CU21M100	MS 100A + 19 Outgoing ways
	CU21R80	RCD 80A + 19 Outgoing ways
	CU21SL10080	MS 100A/RCD 80A Split Load + 17 Outgoing ways
	CU21DR10063	MS 100A/2 x RCD 80A + 15 Outgoing ways
	CU21RRM10063	MS 100A + 3RCBO Outgoing /2 x RCD 63A+12 Outgoing ways
24 Modules	CU24M125	MS 125A + 22 Outgoing ways
	CU24R80	RCD 80A + 22 Outgoing ways
	CU24SL12580	MS 125A/RCD 80A Split Load + 20Outgoing ways
	CU24DR12580	MS 125A/2 x RCD80A + 18 Outgoing ways
	CU24RRM12580	MS 125A + 4 RCBO Outgoing /2 x RCD 80A+14 Outgoing ways

Combined Socket Distribution Box

Waterproof, dustproof, anticorrosion, high-strength insulation. Any openings in accordance with the requirements of users, it is very complete in specification and convenient in installation.

Remark: DBS series and DBB series can be matched freely.

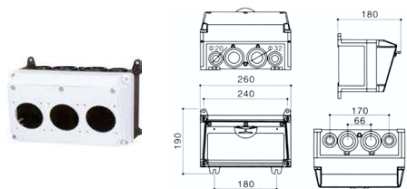

DBS-1P

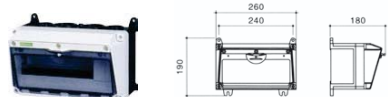

DBB-1P

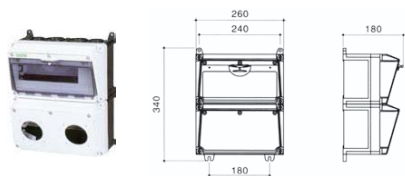

DBS-2P

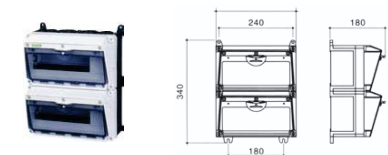

DBB-2P

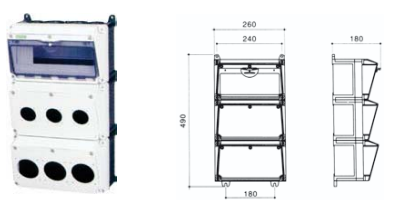

DBS-3P

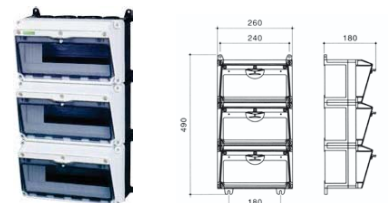

DBB-3P

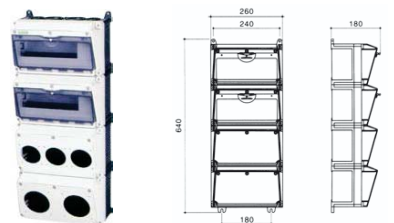

DBS-4P

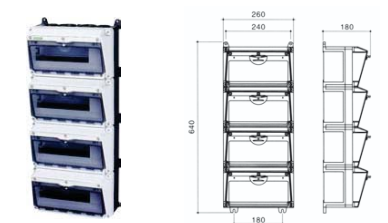

DBB-4P

Portable Socket Distribution Box



SDBC Series

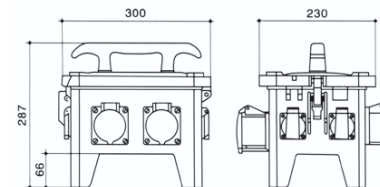

SDBG Series

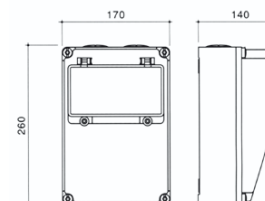

Bar socket device
Size: 300 x 80 x 51mm
I : 16A 230V 3pcs
II : 16A 230V 4pcs
According to French, Belgian,
Danish and Swiss standard

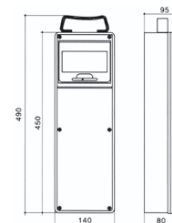

SPB Series

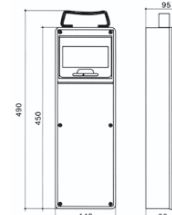

GU Series Of British Junction Box



General

GU Series lighting box is in line with IEC-493-1 standard, attractive and durable, safe and reliable, which is widely used in various places such as factory, mansion, residence, shopping center and so on.

Features

- ◆ With standard of BSEN60439-3
- ◆ 960° UV stop ABS on body and V0 retardant PC on transparent lids.
- ◆ Neutral & Earth terminal link bars assembled
- ◆ Flexible wires connected on correct terminals
- ◆ Live bus-bar fitted to assembled MCBs
- ◆ IP55 waterproof suit for outdoor use

Models and Specifications

Model	Part No.	Description		A	B	C	D	E	F
3 Modules	SUR6340	RCD 63A + MCB B40	3	99	183	106	87	110	42.50
	SUR6350	RCD 63A + MCB B50	5	136	183	106	103	110	42.50
5 Modules	GUM100166	MS 100A + MCBs B16/B6	8	190	183	106	157	110	42.50
	GUR40166	RCD 40A + MCBs B16/B6							
8 Modules	GUR63326	RCD 63A + MCBs B32/B6							
	GUM100/s	MS 100A + 6 Out going ways							
	GUR63/s	RCD 63A + 6 Out going ways							

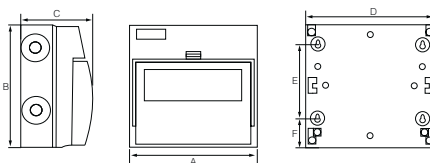

SKB Series Of Socket Box



General

These boxes are of a rugged construction and when correctly installed provide protection against the ingress of both dust and moisture. They are also fitted with a flexible membrane to provide added protection when in use with a plug and cable installed.

Installation

Select cable entry position in mounting box and remove knockout, fit 20mm cable gland or grommet
Fix box securely to mounting surface (use all 4 fixing points supplied) being sure to only mount it vertically with the "Arrow" symbol upwards.
Switches or sockets to be mounted as required, RCD Sockets and spurs may also be fitted but need to check depth first.

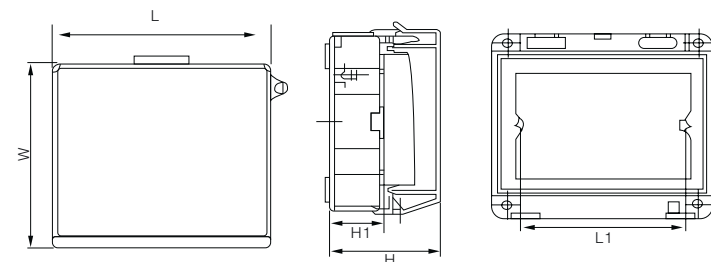

Model	Dimensions (mm)				
	L	W	L1	H	H1
One Gang	101	135	60	80.5	36.5
Two Gang	162	135	120	80.5	36.5
Dual One Gang	200	135	150	80.5	36.5

PJB Series European Junction Box



General

- ◆ It is made of materials such as ABS and PC, etc, elegant external shape, high firmness. Combined body and cover are fixed with four plastic screws that are difficult to fall off. Its specification and size can be designed based on the customer requirements. Economic and affordable. Net weight only accounts for the iron box of about 1/4, to facilitate handling and operation, no corrosion, good insulation.
- ◆ Waterproof junction box purpose: electrical, electronics, communication, fire fighting equipment, control panel, terminal box, large factory, coastal plant, environmental hazard facility, etc.
- ◆ Materials can be selected according to the customer's requirements.

Dimension of Installation

Model	Specification	Dimension(mm)
Opaque Type	PJB-O/85855	85 × 85 × 50
	PJB-O/10107	100 × 100 × 70
	PJB-O/15117	150 × 100 × 70
	PJB-O/20107	200 × 100 × 70
	PJB-O/20158	200 × 155 × 80
	PJB-O/20208	200 × 200 × 80
	PJB-O/25208	255 × 200 × 80
	PJB-O/302512	300 × 250 × 120

Model	Specification	Dimension(mm)
Transparent Type	PJB-T/855055	85 × 50 × 55
	PJB-T/85806	85 × 80 × 60
	PJB-T/11807	110 × 80 × 70
	PJB-T/10107	100 × 100 × 70
	PJB-T/12107	120 × 100 × 70
	PJB-T/15117	150 × 110 × 70
	PJB-T/171275	175 × 125 × 75
	PJB-T/15158	150 × 150 × 80
	PJB-T/20108	200 × 100 × 80
	PJB-T/18188	180 × 180 × 80
	PJB-T/201510	200 × 155 × 100
	PJB-T/202010	200 × 200 × 100
	PJB-T/252010	250 × 200 × 100
	PJB-T/302513	300 × 250 × 130
	PJB-T/403513	400 × 350 × 130

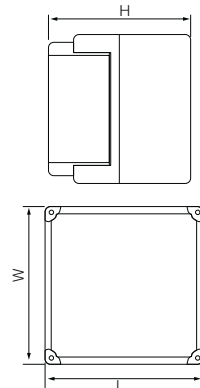

PCB Series Of Plastic Connection Box



General

- ◆ It is made of materials such as ABS and PC, etc, elegant external shape, high firmness. Combined body and cover are fixed with four plastic screws that are difficult to fall off. Its specification and size can be designed based on the customer requirements. Economic and affordable. Net weight only accounts for the iron box of about 1/4, to facilitate handling and operation, no corrosion, good insulation.
- ◆ Waterproof junction box purpose: electrical, electronics, communication, fire fighting equipment, control panel, terminal box, large factory, coastal plant, environmental hazard facility, etc.
- ◆ Materials can be selected according to the customer's requirements.

Dimension of Installation

Specification	Dimension(mm)
PCB	200 × 155 × 60
	200 × 155 × 80
	300 × 200 × 40
	300 × 200 × 60
	300 × 200 × 80
	300 × 300 × 80

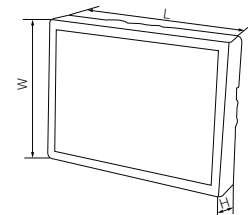

Switch Box Series



General

- ◆ The enclosure is free corrosion, compressive property and insulation, can be waterproof and dustproof, Manufactured from ABS and PC, adequate for terminal interchange, button box, small terminal, relay, sensor and communication box etc.
- ◆ Protection degree: IP66

Transparent Cover

Dimension	Model	Dimension			Mounting plate	
		W	H	D	Plastic	Metal
	OP-AG-0506	50	65	55	---	---
	OP-AG-0609	65	95	55	---	---
	OP-AG-0811-S	80	110	45	OP-0811P	OP-0811
	OP-AG-0811-1S	80	110	60	OP-0811P	OP-0811
	OP-AG-0811	80	110	70	OP-0811P	OP-0811
	OP-AG-0813	80	130	70	OP-0813P	OP-0813
	OP-AG-0816-S	80	160	55	OP-0816P	OP-0816
	OP-AG-0816	80	160	90	OP-0816P	OP-0816
	OP-AG-0818	80	180	70	OP-0818P	OP-0818
	OP-AG-0825	80	250	70	OP-0825P	OP-0825
	OP-AG-0811-1	80	110	85	OP-0811P	OP-0811
	OP-AG-0813-1	80	130	85	OP-0813P	OP-0813
	OP-AG-0818-1	80	180	85	OP-0818P	OP-0818
	OP-AG-0825-1	80	250	85	OP-0825P	OP-0825
Body:	OP-AG-1212-S	125	125	75	OP-1212P	OP-1212
ABS/grey	OP-AG-1212	125	125	100	OP-1212P	OP-1212
	OP-AG-1217	125	175	75	OP-1217P	OP-1217
Cover:	OP-AG-1217-1	125	175	100	OP-1217P	OP-1217
ABS/grey	OP-AG-1417	140	170	95	OP-1417P	OP-1417
	OP-AG-1520	150	200	100	OP-1520P	OP-1520
	OP-AG-1520-1	150	200	130	OP-1520P	OP-1520
	OP-AG-1525	150	250	100	OP-1525P	OP-1525
	OP-AG-1525-1	150	250	130	OP-2025P	OP-2025
	OP-AG-2020	200	200	130	OP-2020P	OP-2020
	OP-AG-2020-S	200	200	95	OP-2020P	OP-2020
	OP-AG-1717-1	175	175	100	OP-1717P	OP-1717
	OP-AG-1725	175	250	75	OP-1725P	OP-1725
	OP-AG-1725-1	175	250	100	OP-1725P	OP-1725
	OP-AG-0712	75	125	75	OP-0712P	OP-0712
	OP-AG-0712-1	75	125	100	OP-0712P	OP-0712
	OP-AG-1423	140	230	90	OP-1423P	OP-1423
	OP-AG-1717	175	175	75	OP-1717P	OP-1717

Grey Cover

Dimension	Model	Dimension			Mounting plate	
		W	H	D	Plastic	Metal
	OP-AT-0506	50	65	55	---	---
	OP-AT-0609	65	95	55	---	---
	OP-AT-0811-S	80	110	45	OP-0811P	OP-0811
	OP-AT-0811-1S	80	110	60	OP-0811P	OP-0811
	OP-AT-0811	80	110	70	OP-0811P	OP-0811
	OP-AT-0813	80	130	70	OP-0813P	OP-0813
	OP-AT-0816-S	80	160	55	OP-0816P	OP-0816
	OP-AT-0816	80	160	90	OP-0816P	OP-0816
	OP-AT-0818	80	180	70	OP-0818P	OP-0818
	OP-AT-0825	80	250	70	OP-0825P	OP-0825
	OP-AT-0811-1	80	110	85	OP-0811P	OP-0811
	OP-AT-0813-1	80	130	85	OP-0813P	OP-0813
	OP-AT-0818-1	80	180	85	OP-0818P	OP-0818
	OP-AT-0825-1	80	250	85	OP-0825P	OP-0825
Body:	OP-AT-1212-S	125	125	75	OP-1212P	OP-1212
ABS/grey	OP-AT-1212	125	125	100	OP-1212P	OP-1212
	OP-AT-1217	125	175	75	OP-1217P	OP-1217
Cover:	OP-AT-1217-1	125	175	100	OP-1217P	OP-1217
PC/clear	OP-AT-1417	140	170	95	OP-1417P	OP-1417
	OP-AT-1520	150	200	100	OP-1520P	OP-1520
	OP-AT-1520-1	150	200	130	OP-1520P	OP-1520
	OP-AT-1525	150	250	100	OP-1525P	OP-1525
	OP-AT-1525-1	150	250	130	OP-2025P	OP-2025
	OP-AT-2020	200	200	130	OP-2020P	OP-2020
	OP-AT-2020-S	200	200	95	OP-2020P	OP-2020
	OP-AT-1717-1	175	175	100	OP-1717P	OP-1717
	OP-AT-1725	175	250	75	OP-1725P	OP-1725
	OP-AT-1725-1	175	250	100	OP-1725P	OP-1725
	OP-AT-0712	75	125	75	OP-0712P	OP-0712
	OP-AT-0712-1	75	125	100	OP-0712P	OP-0712
	OP-AT-1423	140	230	90	OP-1423P	OP-1423
	OP-AT-1717	175	175	75	OP-1717P	OP-1717

Switch Box Series



Assembly Conventional Diagram

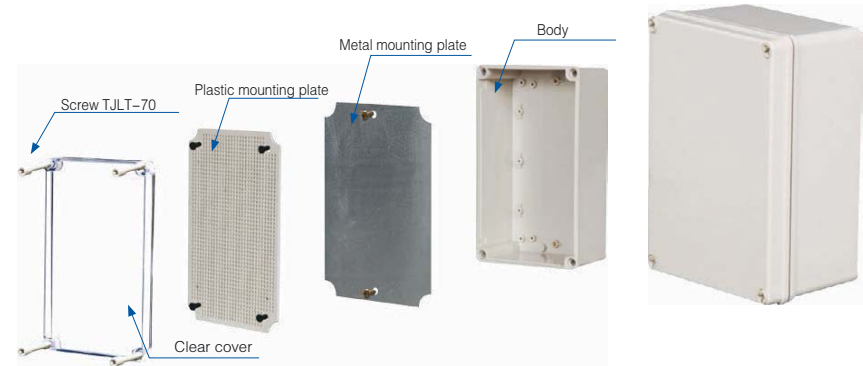

Dimension	H1	H2	H3	H4	W1	W2	W3	O1	O2
OP-0508	65	59	52	40	50	44	37	35	20
OP-0712	125	120	107	90	75	70	57	52	25
OP-0712-1	125	120	107	90	75	70	57	52	50
OP-0811-S	110	104	92	80	80	74	62	25	20
OP-0811	110	104	92	80	80	74	62	60	20
OP-0811-1	110	104	92	80	80	74	62	50	35
OP-0813	130	124	112	100	80	74	62	50	20
OP-0813-1	130	124	112	100	80	74	62	60	35
OP-0816-S	162	156	148	140	82	76	88	40	15
OP-0816	162	156	148	140	82	76	88	75	15
OP-0818	180	174	162	150	80	74	62	60	20
OP-0818-1	180	174	162	150	80	74	62	50	35
OP-0825	260	244	232	220	80	74	62	60	20
OP-0825-1	260	244	232	220	80	74	62	60	35
OP-1212-S	125	117	105	70	125	117	105	55	20
OP-1212	125	117	105	70	125	117	105	80	20
OP-1217	175	167	157	140	127	121	109	49	25
OP-1217-1	175	167	157	140	127	121	109	49	50
OP-1417	170	162	152	130	140	132	122	75	20
OP-1520	200	190	182	160	150	139	132	80	20
OP-1520-1	200	190	182	160	150	139	132	80	50
OP-1525	250	240	232	210	150	140	132	80	20
OP-1525-1	250	240	232	210	150	140	132	80	50
OP-1717	175	170	157	140	175	170	157	52	25
OP-1717-1	175	170	157	140	175	170	157	52	50
OP-1725	250	245	232	211	175	170	157	52	25
OP-1725-1	250	245	232	211	175	170	157	52	50
OP-2020-S	200	193	182	120	200	193	182	75	20
OP-2020	200	193	182	120	200	193	182	110	20

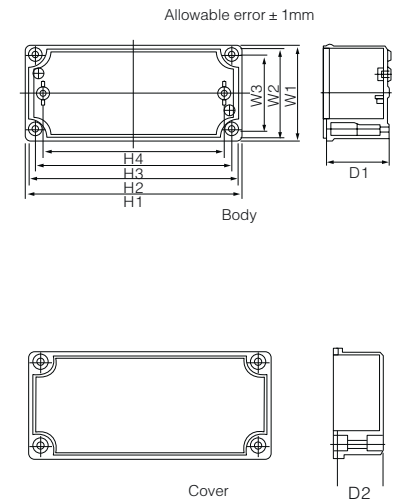

Big Box Series



General

- ◆ The enclosure is according to EN60529 standard, free from corrosion, compressive property and insulation, widely used in electronics, communications, fire fighting apparatus, control panels, terminal boxes, public accommodation, ship industry, food industry etc. We always give top priority to quality and safety, your satisfaction is guaranteed.
- ◆ Protection degree: IP66
- ◆ Temperature range: -40°C to +80°C
- ◆ ABS: Acrylonitrile Butadiene Styrene PC: Poly Carbonate

Grey Cover

Dimension	Model	Dimension			Mounting plate	
		W	H	D	Plastic	Metal
Body: ABS/grey	OP-AG-2819	280	190	130	OP-2819P	OP-2819
	OP-AG-2819-1	280	190	180	OP-2819P	OP-2819
	OP-AG-2828	280	280	130	OP-2828P	OP-2828
	OP-AG-3428	340	280	130	OP-3428P	OP-3428
Cover: ABS/grey	OP-AG-3428-1	280	380	180	OP-3428P	OP-3428
	OP-AG-3828	280	380	130	OP-3828P	OP-3828
	OP-AG-3828-1	280	380	180	OP-3828P	OP-3828
	OP-AG-2828-1	280	280	180	OP-2828P	OP-2828

Transparent Cover

Dimension	Model	Dimension			Mounting plate	
		W	H	D	Plastic	Metal
Body: ABS/grey	OP-AT-2819	280	190	130	OP-2819P	OP-2819
	OP-AT-2819-1	280	190	180	OP-2819P	OP-2819
	OP-AT-2828	280	280	130	OP-2828P	OP-2828
	OP-AT-3428	340	280	130	OP-3428P	OP-3428
Cover: PC/clear	OP-AT-3428-1	280	380	180	OP-3428P	OP-3428
	OP-AT-3428	280	380	130	OP-3828P	OP-3828
	OP-AT-3428-1	280	380	180	OP-3828P	OP-3828
	OP-AT-2828-1	280	280	180	OP-2828P	OP-2828

Big Box Series



Assembly Conventional diagram

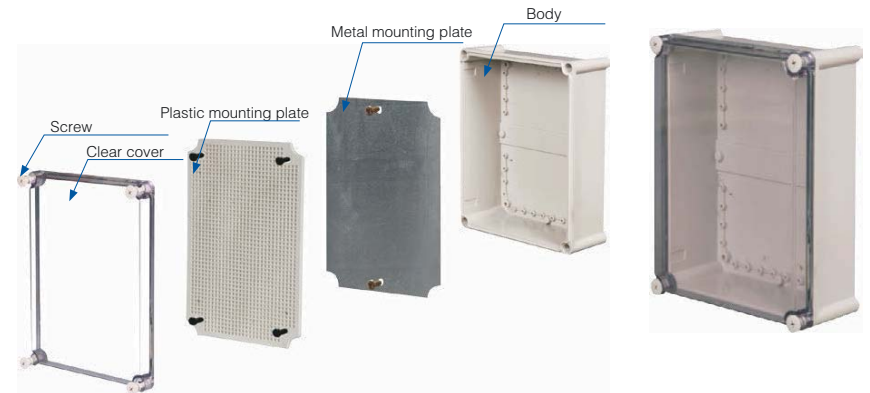

Dimension	H1	H2	H3	H4	W1	W2	W3	W4	D1	D2
OP-2819	280	266	255	210	190	170	165	120	98	30
OP-2819-1	280	266	255	210	190	170	165	120	98	30
OP-2828	280	260	255	210	280	260	255	210	98	80
OP-2828-1	280	260	255	210	280	260	255	210	98	30
OP-2834	341	320	316	270	280	260	256	210	100	30
OP-2838	380	359	355	310	280	259	255	210	98	30
OP-2838-1	380	359	355	310	280	259	255	210	98	80

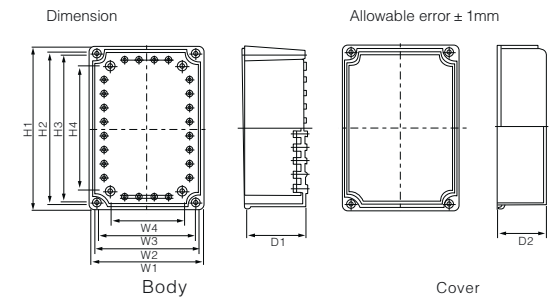

Stainless Steel Latch Series



General

- ◆ The enclosure are widely used in assemble of control box, terminal boxes, power distribution panels and instrument container. With the practical of stainless steel latch, hinges and special locking device, it has been widely recognized by our customer. The types of products and accessories complete, can meet your different needs.
- ◆ Protection degree: IP66
- ◆ Temperature range: -40°C to +80°C
- ◆ ABS: Acrylonitrile Butadiene Styrene
PC: Poly Carbonate

Grey Cover

Dimension	Model	Dimension W H D	MountinT plate	
			Plastic	Metal
	OP-AGH-0506	50 × 65 × 55	--	--
	OP-AGH-0609	65 × 95 × 55	--	--
	OP-AGH-0811-S	80 × 110 × 45	OP-0811P	OP-0811
	OP-AGH-0811	80 × 110 × 70	OP-0811P	OP-0811
	OP-AGH-0813	80 × 130 × 70	OP-0813P	OP-0813
	OP-AGH-0816-S	80 × 160 × 55	OP-0816P	OP-0816
	OP-AGH-0816	80 × 160 × 90	OP-0816P	OP-0816
	OP-AGH-0818	80 × 180 × 70	OP-0818P	OP-0818
	OP-AGH-0825	80 × 250 × 70	OP-0825P	OP-0825
	OP-AGH-0811-1	80 × 110 × 85	OP-0811P	OP-0811
	OP-AGH-0813-1	80 × 130 × 85	OP-0813P	OP-0813
	OP-AGH-0818-1	80 × 180 × 85	OP-0818P	OP-0818
	OP-AGH-0825-1	80 × 250 × 85	OP-0825P	OP-0825
Body:	OP-AGH-1212-S	125 × 125 × 75	OP-1212P	OP-1212
ABS/grey	OP-AGH-1212	125 × 125 × 100	OP-1212P	OP-1212
	OP-AGH-1217	125 × 175 × 75	OP-1217P	OP-1217
Cover:	OP-AGH-1217-1	125 × 175 × 100	OP-1217P	OP-1217
ABS/grey	OP-AGH-1417	140 × 170 × 95	OP-1417P	OP-1417
	OP-AGH-1520	150 × 200 × 100	OP-1520P	OP-1520
	OP-AGH-1520-1	150 × 200 × 130	OP-1520P	OP-1520
	OP-AGH-1525	150 × 250 × 100	OP-1525P	OP-1525
	OP-AGH-1525-1	150 × 250 × 130	OP-1525P	OP-1525
	OP-AGH-2020	200 × 200 × 130	OP-2020P	OP-2020
	OP-AGH-2020-S	200 × 200 × 95	OP-2020P	OP-2020
	OP-AGH-1717-1	175 × 175 × 100	OP-1717P	OP-1717
	OP-AGH-1725	175 × 250 × 75	OP-1725P	OP-1725
	OP-AGH-1725-1	175 × 250 × 100	OP-1725P	OP-1725
	OP-AGH-0712	75 × 125 × 75	OP-0712P	OP-0712
	OP-AGH-0712-1	75 × 125 × 100	OP-0712P	OP-0712
	OP-AGH-1423	140 × 230 × 90	OP-1423P	OP-1423
	OP-AGH-1717	175 × 175 × 75	OP-1717P	OP-1717

Plastic Latch And Hinge Series



General

- ◆ The enclosure made by ABS and PC, one side install plastic latch, the other side is hinges weight of the metal box 1/4, easy for handling and operation. The product is waterproof and dustproof, adequate for small terminal boxes, relay, calculator, junction box etc.
- ◆ Protection degree: IP66
- ◆ Temperature range: -40°C to +80°C
- ◆ ABS: Acrylonitrile Butadiene Styrene PC: Poly Carbonate

Grey door

Model	Dimension W H D	Mounting plate
		Model
OP-MG-2030	200 × 300 × 150	OP-2030
OP-MG-3030	300 × 300 × 180	OP-3030
OP-MG-4030	400 × 300 × 180	OP-4030

Clear door

Model	Dimension W H D	Mounting plate
		Model
OP-MT-2030	200 × 300 × 150	OP-2030
OP-MT-3030	300 × 300 × 180	OP-3030
OP-MT-4030	400 × 300 × 180	OP-4030

Plastic latch + Hinges Series



Dimension W H D	Plastic latch + hinge type		Mounting plate		Dimension		
	Grey Cover	Clear Cover	Plastic	Metal	H3	W3	D1+D2
100 × 150 × 70	TE-AG-1050	OP-AT-2819	OP-1050P	OP-1050	125	75	68
100 × 200 × 70	TE-AG-1020	OP-AT-2819-1	OP-1020P	OP-1020	175	75	68
150 × 200 × 90	TE-AG-1515	OP-AT-2828	OP-1515P	OP-1515	175	125	88
170 × 220 × 110	TE-AG-1722	OP-AT-3428	OP-1722P	OP-1722	195	145	108
190 × 290 × 140	TE-AG-1929	OP-AT-3428-1	OP-1929P	OP-1929	265	165	138
290 × 390 × 160	TE-AG-2939	OP-AT-3428	OP-2939P	OP-2939	365	265	158

Lock And Hinge Series



General

- ◆ The enclosure made by ABS and PC, one side install 3mm double locks, the other side is hinges, weight of the metal box 1/4, easy for handling and operation. The product is waterproof and dustproof, adequate for small terminal boxes, relay, calculator, junction box etc.
- ◆ Protection degree: IP66
- ◆ Temperature range: -40°C to +80°C

Grey door

Model	Dimension			Mounting plate
	W	H	D	Model
OP-KG-2030	200	300	150	OP-2030
OP-KG-3030	300	300	180	OP-3030
OP-KG-4030	400	300	180	OP-4030

Clear door

Model	Dimension			Mounting plate
	W	H	D	Model
OP-KT-2030	200	300	150	OP-2030
OP-KT-3030	300	300	180	OP-3030
OP-KT-4030	400	300	180	OP-4030

TIP Series Polyester Enclosure



General

TIP series are new type, it made by polyesters, The characteristics of the polyesters is its own mix 30% fiber glass, make it reached high resistance and mechanical stiffness, have the same effect of metal enclosure which is 3 times heavier than it. Compared with metal enclosure, TIP series are lighter, more adequate for corrosion and humid environment.

Model		Dimension			Metal Mounting plate	Dimension			
Grey Door	Transparent Door	W	H	D		A	F	C	D
TIP-325	TX-325	250	300	140	MP-325	310	150	248	175
TIP-430	TX-430	300	400	200	MP-430	280	120	60	90
TIP-440	TX-440	400	400	200	MP-440	280	220	60	90
TIP-540	TX-540	400	500	200	MP-540	380	220	60	90
TIP-640	TX-640	400	600	230	MP-640	480	220	60	90
TIP-650	TX-650	500	600	230	MP-650	480	320	60	90
TIP-860	TX-860	600	800	300	MP-860	680	420	60	90

Transparent Door

Model	A	B	E	F
TX-325	268	213	248	175
TX-43	358	260	338	222
TX-44	358	360	338	322
TX-54	458	360	438	322
TX-64	558	360	538	322
TX-65	558	460	538	422
TX-86	754	556	734	518

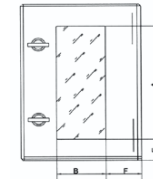

Mounting Plate

Model	A	B	E	F
TX-325	268	213	248	175
TX-43	358	260	338	222
TX-44	358	360	338	322
TX-54	458	360	438	322
TX-64	558	360	538	322
TX-65	558	460	538	422
TX-86	754	556	734	518

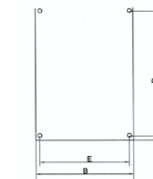

Inner Door

Model	A	B
TP-43	366	258
TP-44	366	358
TP-54	466	358
TP-64	566	358
TP-65	566	458
TP-86	766	658

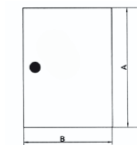

Transparent Contact Protection Window Hood

General

- ◆ It is applicable for special waterproof, dustproof and corrosion-proof locations.
- ◆ The base without protection is available.
- ◆ Executive standard: IEC60529 EN60309
- ◆ Protection degree: IP66
- ◆ Temperature range: -40°C to +80°C
- ◆ ABS: Acrylonitrile Butadiene Styrene PC: Poly Carbonate

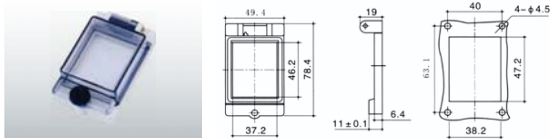

OPWH-2

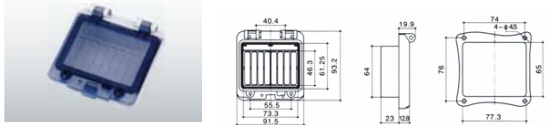

OPWH-4

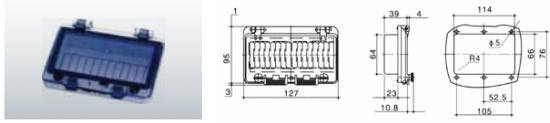

OPWH-6

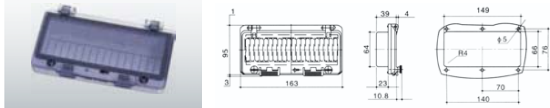

OPWH-8

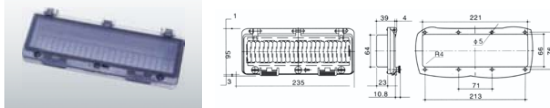

OPWH-12



Transparent window of distribution box

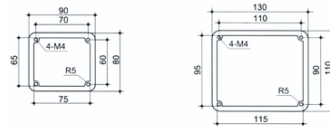

Product appearance



General Junction Box



General Junction Box



General Junction Box



General Junction Box



150 × 110 × 70



150 × 150 × 70



200 × 100 × 70



200 × 155 × 80



200 × 200 × 80



255 × 200 × 80



300 × 250 × 120



400 × 350 × 120



80 × 50



85 × 85 × 50



100 × 100 × 70



150 × 110 × 70

General Junction Box



200 × 100 × 70



200 × 100 × 110



200 × 155 × 80



200 × 200 × 80



255 × 200 × 80



HTC 85 × 85 × 50



HTC 100 × 100 × 70



HTC 150 × 110 × 70



HTC 150 × 150 × 70

AR9000 Floor Stand Cabinet



Single Door AR9000

Supply Include:

- ◆ Front door with reinforcing frame,
- ◆ 4 hinges and a points lock system
- ◆ Rear panel
- ◆ Top cover
- ◆ Mounting plate and 4 mounting plate supports
- ◆ 4 Lifting eyebolts
- ◆ Removable cable gland plate
- ◆ Finish: epoxy polyester powder coating textured finish
- ◆ Profile: 9-fold profile
- ◆ Material: cold rolling steel
- ◆ Front door: 2.0 mm
- ◆ Rear panel: 1.5 mm
- ◆ Mounting plate: zinc coated 2.5 mm
- ◆ Protection degree: IP55
- ◆ Color: RAL 7032 RAL 7035

AR9 168/8	1600 x 800 x 800
AR9 186/4	1800X600X400
AR9 186/5	1800X600X500
AR9 186/6	1800X600X600
AR9 186/8	1800X600X800
AR9 188/4	1800X800X400
AR9 188/5	1800X800X500
AR9 188/6	1800 x 800 x 600
AR9 1810/4	1800x1000X400
AR9 1810/5	1800x1000x500
AR9 1810/6	1800x1000X600
AR9 203/5	2000 x 300 x 500
AR9 203/6	2000x 300 x 600
AR9 203/8	2000X300X800
AR9 204/5	2000 X400 x 500
AR9 204/6	2000 x 400 x 600
AR9 206/4	2000 x 600 X400
AR9 206/5	2000 x 600x 500
AR9 206/6	2000 x 600 x 600
AR9 206/8	2000 x 600 x 800
AR9 208/4	2000 x 800 X400
AR9 208/5	2000 x 800 x 500
AR9 208/6	2000X800X600
AR9 208/8	2000x 800 x 800
AR9 2010/4	2000x1000X400
AR9 2010/5	2000x1000x500
AR9 2010/6	2000 x1000 x 600
AR9 2010/8	2000 x1000x 800
AR9 2012/4	2000x1200X400
AR9 226/8	2200x 600 x 800
AR9 228/6	2200x 800 x 600
AR9 228/8	2200X800X800
AR9 2210/6	2200x1000X600
AR9 2210/8	2200x1000X800

Model	W H D
AR9 146/4	1400X600X400
AR9 146/6	1400X600X600
AR9 146/8	1400X600X800
AR9 148/4	1400X800X400
AR9 148/6	1400x800x600
AR9 148/8	1400 x 800 x 800
AR9 166/6	1600X600X600
AR9 166/8	1600X600X800
AR9 168/6	1600X800X600

AR9000 Floor Stand Cabinet



Double Door AR9000

Model	Dimension W H D
AR9 1810/4	1800X1000X400
AR9 1810/5	1800X1000X500
AR9 1810/6	1800X1000X600
AR9 1812/4	1800X1200X400
AR9 1812/5	1800x1200x500
AR9 1812/6	1800x1200x600
AR9 2010/4	2000X1000X400
AR9 2010/5	2000X1000X500
AR9 2010/6	2000X1000X600

Model	Dimension W H D
AR9 2010/8	2000X1000X800
AR9 2012/4	2000X1200X400
AR9 2012/5	2000X1200X500
AR9 2012/6	2000X1200X600
AR9 2012/8	2000x1200x800
AR9 2210/6	2200x1000x600
AR9 2210/8	2200X1000X800
AR9 2210/6	2200X1200X600
AR9 2210/8	2200X1200X800

Inner door for AR9000 cabinet

Supply Include:

- ◆ Inner door and fixing accessories
- ◆ Lock system
- ◆ Hinges
- ◆ Paint finish: epoxy polyester powder coating textured finish
- ◆ Color: RAL 7032 RAL 7035
- ◆ Protection degree: IP 55
- ◆ Material: cold rolling steel 2.0mm

Model	W	H
ARID 126	600	1200
ARID 128	800	1200
ARID 146	600	1400
ARID 148	800	1400
ARID 166	600	1600
ARID 168	800	1600
ARID 186	600	1800

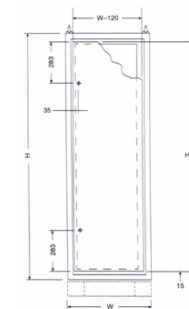

Plexiglass door for AR9000 cabinet

Supply Include:

- ◆ Plexiglass door
- ◆ Lock system
- ◆ Paint finish: epoxy polyester powder coating textured finish
- ◆ Color: RAL 7032 RAL 7035
- ◆ Protection degree: IP 55
- ◆ Material: Plexiglass 4.0mm

Model	W	H
ARPX 126	600	1200
ARPX 128	800	1200
ARPX 146	600	1400
ARPX 148	800	1400
ARPX 166	600	1600
ARPX 168	800	1600
ARPX 186	600	1800

Model	W	H
ARID 126	600	1200
ARID 128	800	1200
ARID 146	600	1400
ARID 148	800	1400
ARID 166	600	1600
ARID 168	800	1600
ARID 186	600	1800



Accessories of AR9000 Modular Cabinets



Modular Cabinets

The OPEN L.T. distribution cabinet is based on the basic AR 9000 system. The design has been carefully carried out to offer a versatile reliable product to meet the requirements of modern L.T. equipment. Modular components and instruments are mounted in the front while the rear is used for bus-bars and interconnections. The MCBs are assembled in horizontal sections one above the other and a similar section at the top can be used to mount the instruments. Alternatively they can be mounted in a vertical column. The units are available with flush compartment doors or optionally with inner door and glazed or blank outer door. Alternatively a cornice frame can be used. Bus-bars, terminations or cable entries can be accommodated in the side section allowing an extremely flexible suite arrangement.

Accessories of AR9000 Modular Cabinets

Multiple Doors

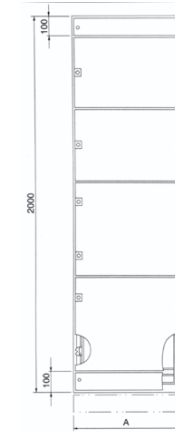

Multiple doors
in 2 mm sheet steel complete with gasket and locking system, hinges

MT: without plexiglass door MTP: with plexiglass door

Model	Model	W	H	H 1	PCS/BAG		
MT602	MTP602	600	200	195	2		
MT603	MTP603		300	295			
MT604	MTP604		400	395			
MT605	MTP605		500	495			
MT606	MTP606		600	595			
MT608	MTP608		800	795			
MT609	MTP609		900	895			
MT6010	MTP6010		1000	995			
MT802	MTP802		800	200		195	2
MT803	MTP803			300		295	
MT804	MTP804	400		395			
MT805	MTP805	500		495			
MT806	MTP806	600		595			
MT808	MTP808	800		795			
MT809	MTP809	900		895			
MT8010	MTP8010	1000		995			

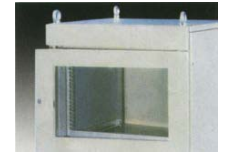

Clamp board
for multiple doors in 1.5mm sheet steel with fixing accessories

Width	PCS/BAG	Model
600mm	5	MT600
800mm	5	MT800



Seal cover
In 1.5mm sheet steel for sealing the top & bottom of cabinets
Supply include 4pcs seal covers & its fixing accessories.

Width	PCS/BAG	Model
600 x 100mm	4	MT006
800 x 100mm	4	MT008



AR8000 One Piece Cabinet



Construction:

- ◆ Back and side panels manufactured in 1.5mm sheet steel.
- ◆ Mounting plate manufactured in 2.5 mm sheet steel.
- ◆ Door Manufactured in 2mm sheet steel with reinforcing frame.
- ◆ Finish: Used to connect into a complete cabinet. powder coating. Structure, door RAL 7035 textured finish.
- ◆ Mounting plate: zinc coated
- ◆ Protection Degree: IP55 to EN60.529 NEMA 12.
- ◆ Supply Include:
 - ◆ Back and side panels(structure)
 - ◆ Mounting plate. (Also available without mounting plate)
 - ◆ 4 mounting plates support.
 - ◆ Front door with reinforcing frame with 4 hinges a 4 point locking system.
 - ◆ 4 lifting eyebolts

Model	W	H	D	NO.OF DOOR
AR8 1010/3	1000	1000	300	2
AR8 128/3	800	1200	300	1
AR8 1210/3	1000	1200	300	2
AR8 1212/4	1200	1200	400	2
AR8 146/3	600	1400	300	1
AR8 146/4	600	1400	400	1
AR8 148/3	800	1400	300	1
AR8 148/4	800	1400	400	1
AR8 1410/4	1000	1400	400	2
AR8 1412/4	1200	1400	400	2
AR8 166/3	600	1600	300	1
AR8 166/4	600	1600	400	1
AR8 168/3	800	1600	300	1
AR8 168/4	1000	1600	300	1
AR8 1610/3	1000	1600	400	2
AR8 1610/4	1200	1600	300	2
AR8 1612/3	1200	1600	300	2
AR8 1612/4	1200	1600	400	2
AR8 186/3	600	1800	300	1

Model	W	H	D	NO.OF DOOR
AR8 186/4	600	1800	400	1
AR8 186/5	600	1800	500	1
AR8 186/6	600	1800	600	1
AR8 188/3	800	1800	300	1
AR8 188/4	800	1800	400	1
AR8 188/5	1800	800	500	1
AR8 188/6	1800	80	600	1
AR8 1810/4	1800	1000	400	2
AR8 1810/5	1800	1000	500	2
AR8 1812/4	1800	1200	400	2
AR8 1812/5	1800	1200	500	2
AR8 1816/4	1800	1600	400	2
AR8 1816/5	1800	1600	500	2
AR8 206/3	2000	600	300	1
AR8 206/4	2000	600	400	1
AR8 206/5	2000	600	500	1
AR8 206/6	2000	600	600	1
AR8 208/3	2000	800	300	1
AR8 208/4	2000	800	400	1
AR8 208/5	2000	800	500	1
AR8 208/6	2000	800	600	1
AR8 2010/4	2000	1000	400	2
AR8 2010/5	2000	1000	500	2
AR8 2012/4	2000	1200	400	2
AR8 2012/5	2000	1200	500	2
AR8 2012/6	2000	1200	600	2
AR8 2016/4	2000	1600	400	2
AR8 2016/5	2000	1600	500	2
AR8 2016/6	2000	1600	600	2

Accessories Of Floor Standing Cabinet



Steel bolt anchor

Hexagon steel proximate matter, supply include its fixing accessories zinc-plating

Model	PCS/SET
WA010	6



Baying bracket

For connection and hanger two devices. Material: sheet zinc-plating

Model	PCS/SET
WAC20	4

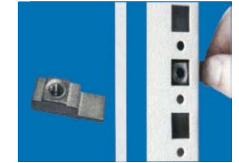

Insert nut

Special designed nut used to install on AR9000 manufactured from zinc alloy

Model	Insert nut	PCS/SET
WA6	M6	50
WA8	M8	50

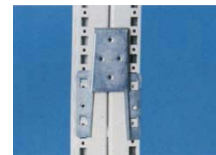

Baying bracket

Special designed nut used to install on AR9000 manufactured from zinc alloy

Model	PCS/SET
WA030	1



Sealing rubber for 2 devices

Introduction	Length	Package	Model
For sealing the gap between 2 devices	10m/roll	1pcs	RUB001



Perforated rail

Pack: 12 set
RAILS 23 x 23mm WHD
Using angle bracket WHD001 install on the enclosure
Supply include: 1 set(1 pcs left bracket, 1 pcs right bracket, 2 pcs screws BZ5.5 x 13)

Model	WHD400	WHD500	WHD600	WHD800	WHD1000	WHD1200	WHD1600	WHD1800	WHD2000	WHD2200
Leight	295	395	495	695	895	1095	1495	1695	1895	2095
W H D	400	500	600	800	1000	1200	1600	1800	2000	2200
PCS/SET	12	12	12	12	12	12	6	6	6	6



Side cover

Material: sheet steel in 1.5 mm
Finish: The product standard cycle thermosetting epoxy polyester.
Powder coating: RAL 7032 finish.
Supply: 2 pcs side covers & its fixing accessories

Model	Height	Depth
ARSP 124	1200	400
ARSP 126	1200	600
ARSP 128	1200	800
ARSP 148	1400	400
ARSP 146	1400	600
ARSP 148	1600	800
ARSP 166	1600	600
ARSP 168	1800	800
ARSP 184	1800	400
ARSP 185	1800	500
ARSP 186	1800	600
ARSP 188	2000	800
ARSP 204	2000	400
ARSP 205	2000	500
ARSP 206	2000	600
ARSP 208	2000	800
ARSP 226	2200	600
ARSP 228	2200	800

Accessories Of Floor Standing Cabinet

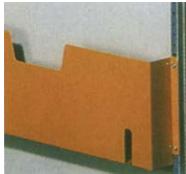

Plan pocket

For Cabinet Width	Sizz (mm)		
	W	H	D
PP400	255	260	90
PP500	355	260	90
PP600	455	260	90
PP800	655	260	90
PP900	755	260	90
PP1000	855	260	90



A4 Plastic Plan Pocket

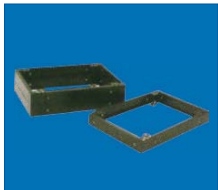

AR8000-AR9000 base

Construction:
Standard plinth: H=100, H=200
1.5mm pressed sheet steel corner.
Finish: The product standard cycle thermosetting epoxy polyester.
Powder coating: RAL 6022

Model	Model	Plinth Size	Cabinet Size	Model	Model	Plinth Size	Cabinet Size		
H100	H200	mm	Width	Depth	H100	H200	Width	Depth	
PL1 35	PL2 35	300 x 440	300	500	PL1 86	PL2 86	800 x 540	800	600
PL1 36	PL2 36	300 x 540	300	600	PL1 88	PL2 88	800 x 740	800	800
PL1 38	PL2 38	300 x 740	300	800	PL1 104	PL2 104	1000 x 340	1000	400
PL1 45	PL2 45	400 x 440	400	500	PL1 105	PL2 105	1000 x 440	1000	500
PL1 46	PL2 46	600 x 540	400	600	PL1 106	PL2 106	1000 x 540	1000	600
PL1 64	PL2 64	600 x 340	600	400	PL1 108	PL2 108	1000 x 740	1000	800
PL1 65	PL2 65	600 x 440	600	500	PL1 124	PL2 124	1200 x 340	1200	400
PL1 66	PL2 66	600 x 540	600	600	PL1 125	PL2 125	1200 x 440	1200	500
PL1 68	PL2 68	600 x 740	600	800	PL1 126	PL2 126	1200 x 540	1200	600
PL1 84	PL2 84	800 x 340	800	400	PL1 128	PL2 128	1200 x 740	1200	800
PL1 85	PL2 85	800 x 440	800	500					



Door stop

Support door to door always open

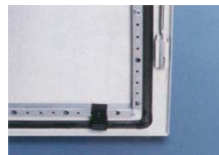

Inertia of the pulley

The door closed lift auxiliary equipment



Computer pallet frame

It is a programming unit pallet, fixed on door frame, easy to turn down in maintaining and return between door frame after maintained.

	Depth	Cabinet width
413	400	600
613	400	600



Cable gatherer board

Cabinet width	Cabinet width	Cabinet width	Model
600	5	2	
800	8	2	
1000	10	2	
1200	12	2	



Cable duct tube

		Cabinet width	Model
8	13	25	
3	21	25	
1	47	25	

Accessories Of Floor Standing Cabinet



Cable gripper

Cabinet width	400	600	800	850	1000	1200	1600	1800
Length	385	585	785	835	985	1185	1585	1785
Pcs/set	2	2	2	2	2	2	2	2
model								



Angle iron ring

Material: steel, galvanized, chromated

Cabinet width	6-12	12-16	14-18	18-22	22-26	26-30	30-34	34-38	38-42	42-46	46-50
Pcs/set	25	25	25	25	25	25	25	25	25	25	25
model											



Cable gripper

Cabinet width	Cabinet width	Cabinet width	Model
600	5	2	
800	8	2	
1000	10	2	
1200	12	2	



WA 065 Ring

Model: WA065 4pcs/set with fixing accessories

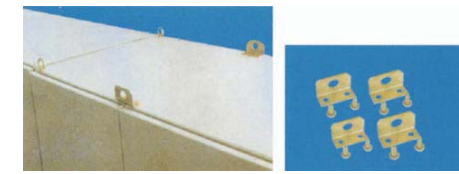

WL 300 Bracket

Model: WL300 4pcs/set with fixing accessories

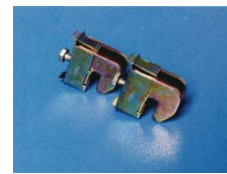

Series SU bar without pinholes lead terminal

Thickness of bus	Round lead wiring	Piled copper bus terminal space	tightening turning moment	Per package	Type Su
4-5mm	1-4mm ²	-	2Nm	50pcs	201
4-5mm	2.5-16mm ²	8 x 8mm	3Nm	50pcs	202
4-5mm	16-50mm ²	10.5 x 11mm	6-8Nm	50pcs	203
4-5mm	35-70mm ²	16.5 x 15mm	10-12Nm	50pcs	204
4-5mm	70-185mm ²	22.5 x 20mm	12-15Nm	50pcs	205
9-10mm	1-4mm ²	-	2Nm	50pcs	206
9-10mm	2.5-16mm ²	8 x 8mm	3Nm	50pcs	207
9-10mm	16-50mm ²	10.5 x 11mm	6-8Nm	50pcs	208
9-10mm	35-70mm ²	16.5 x 15mm	10-12Nm	50pcs	209
9-10mm	70-185mm ²	22.5 x 20mm	12-15Nm	50pcs	300

Accessories



Fliter fan

ABS synthetic resin, fire resistant and UV-Resistant, dustproof coefficient: 80%.

Model	The outer part	Efficient blast volume	Collection coefficient	Level of protection	Applicable blower fan
FU-9801A	φ 105mm	8.00m ³ /min	80%	IP44	SJ8025
FU-9802A	φ 120mm	12.0m ³ /min	80%	IP44	SJ9225
FU-9803A	148.5 × 148.5 × 13.5mm	25.0m ³ /min	80%	IP44	SJ1238
FU-9804A	204 × 204 × 13.5mm	50.0m ³ /min	86%	IP44	SJ1725
FU-9805A	255 × 255 × 13.5mm	80.0m ³ /min	86%	IP44	SJ1725, SJ2206, SJ2072
FU-9806A	320 × 320 × 13.5mm	120m ³ /min	86%	IP44	SJ1725, SJ2072, SJ2509

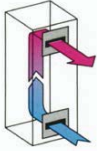

Model	The outer part	Bearing	Collection coefficient	Level of protection	Applicable blower fan
SJ8025HA2	80 × 80 × 25mm	Sleeve/Ball	80%	IP44	SJ8025
SJ9225HA2	92 × 92 × 25mm	Sleeve/Ball	80%	IP44	SJ9225
SJ1238HA2	120 × 120 × 38mm	Sleeve/Ball	80%	IP44	SJ1238
SJ1725HA2	172 × 150 × 51mm	Sleeve/Ball	86%	IP44	SJ1725
SJ2072HA2	208 × 208 × 72mm	Ball	86%	IP44	SJ1725, SJ2206, SJ2072
SJ2206HA2	φ 220 × 60mm	Ball	86%	IP44	SJ1725, SJ2072, SJ2509
SJ2509HA2	φ 250 × 90mm	Ball			

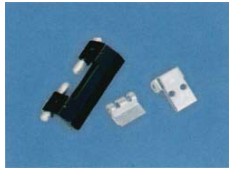

130° Hinge

Model: OP-CH130 6pcs/set with fixing accessories



Self tapping screw

Screw type	Dimension	QTY
Self tapping screw	M5X10	100



LOCK MS 821

1 pcs/set with lock system, key and fixing accessories



LOCK MS 830

1 pcs/set with lock system, key and fixing accessories

Accessories



Door rails

Manufactured from 1.5mm sheet steel

Model	For cabinet width
WA 045	600
WA 046	800
WA 047	1000

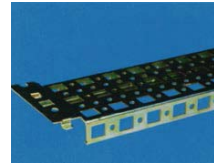

Rails with mounting flange

Pack: 4pcs

With 5 rows of universal skeletal structures of particle assembly.

Manufactured in 1.5mm zinc passivated sheet steel with 8pcs fixing screws M5 × 13mm

Model	For depth of cabinet				For depth of cabinet			
	WD400	WD500	WD600	WD800	WW600	WW800	WW1000	WW1200
Dimension	400	500	600	800	600	800	1000	1200
PCS/SET	4	4	4	4	4	4	4	4



Divided plate

Divide plate manufactured from 1.5mm sheet steel with fixing accessories

Cabinet width	600	800	800	1000	1000	1200	1200
W × H(mm)	492 × 333	692 × 133	692 × 533	892 × 333	892 × 533	1092 × 133	1092 × 533
PCS/SET	2	2	2	2	2	2	2
Model	MP 64	MP 82	MP 86	MP 104	MP 106	MP 122	MP 124

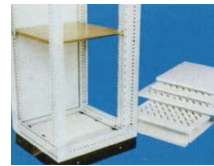

Components pallet

Two type: max carrying ability 50KG max carrying ability 100KG

Material: manufactured from 1.5mm sheet steel with fixing accessories.

Max. weight	DXW	50KG W/T holes		100KG W/T holes	
		Model	Model	Model	Model
600	471 × 300	MPH 604	MPH 604N	MPH 604F	
	471 × 400	MPH 605	MPH 605N	MPH 605F	
	471 × 500	MPH 606	MPH 606N	MPH 606F	
800	671 × 300	MPH 804	-	MPH 804F	
	671 × 400	MPH 805	-	MPH 805F	
	671 × 500	MPH 806	-	MPH 806F	

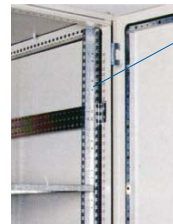

Rails for components pallet



Model	Height
H1400	1400mm
H1600	1600mm
H1800	1800mm
H2000	2000mm
H2200	2200mm

AR6000 Control Desk



Supply include:

- ◆ Front/rear door and operation panel can be opened for convenient installation.
- ◆ Door are welded with perforated strips at the door sides.
- ◆ Mounting plate can move back and forth thus the installation can be more flexible.
- ◆ Finish: epoxy polyester powder coating textured finish.
- ◆ Material: Enclosure & door is cold rolling steel. Mounting plate is zinc coated steel.
- ◆ Enclosure & door: 2.0mm
- ◆ Mounting plate: 2.5mm
- ◆ Protection degree: IP55
- ◆ Color: RAL 7032

AM series control desk(include AE,ME)

Model	AE			ME			
	A	B	C	L	M	N	O
AM41	600	770	400	650	612	123	252
AM42	800	770	400	650	612	123	252
AM43	1000	770	400	650	612	123	252
AM44	1200	770	400	650	612	123	252
AM45	1600	770	400	650	612	123	252
AM51	600	770	500	750	712	123	275
AM52	800	770	500	750	712	123	275
AM53	1000	770	500	750	712	123	275
AM54	1200	770	500	750	712	123	275
AM55	1600	770	500	750	712	123	275

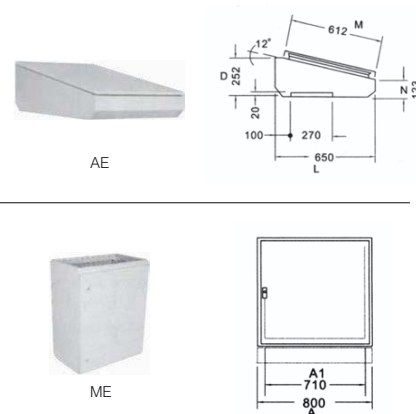

AR6000 Control Desk



Supply include:

- ◆ AE Part front door, Mounting plate, locating part.
- ◆ LE part for operation panel , 2 pcs Panel support.
- ◆ PE Part front door, mounting plate.
- ◆ Material: cold rolled steel
- ◆ Finish: epoxy polyester powder coating textured finish
- ◆ Color: PAL 7032/RAL7035

ALP series control desk(include AE,LE,PE)

Model	AE			LE				PE			
	A	B	C	D	E	F	G	H	I	J	K
AM41	600	770	400	200	835	120	425	370	295	460	425
AM42	800	770	400	200	835	120	425	370	295	460	425
AM43	1000	770	400	200	835	120	425	370	295	460	425
AM44	1200	770	400	200	835	120	425	370	295	460	425
AM45	1600	770	400	200	835	120	425	370	295	460	425
AM51	600	770	500	200	835	120	425	440	365	460	425
AM52	800	770	500	200	835	120	425	400	365	460	425
AM53	1000	770	500	200	835	120	425	440	365	460	425
AM54	1200	770	500	200	835	120	425	440	365	460	425
AM55	1600	770	500	200	835	120	425	440	365	460	425

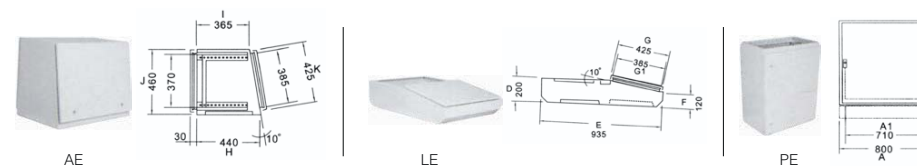

Wall Mount Enclosure



General

- ◆ Our ST range of enclosures are the best available on the market.
- ◆ A well engineered project which has been continuously updated and improved has created a wide range of possible variations, Enclosures are available in portrait, landscape and 2 door configurations.
- ◆ The main characteristic of the OPEN box is the robust construction achieved by a careful mix of design, automated production system and top quality materials, including:
 - ◆ – high performance technology used for locking systems and hinge pins.
 - ◆ – zinc alloy for hinges.
 - ◆ – thermosetting epoxy polyester powder coating for finishes.
 - ◆ – 2 component polyurethane for machine applied seal profile.
 - ◆ – sheet steel.
- ◆ The ST ox has many distinctive features. Large size cable entry(4 sizes) with removable, flush gland plates.
- ◆ Standard door mounted rails for fixing trunk or wiring.
- ◆ Reversible door with screwed hinges on body.
- ◆ Gasket protection clip for transport and storage

CONFORMITY AND APPROVAL

ISO9001 RoHS CE IP66 UL BAUART GEPRÜFT TYPE APPROVED



Note:
Color of picture is likely different from real, because of printing color variation.

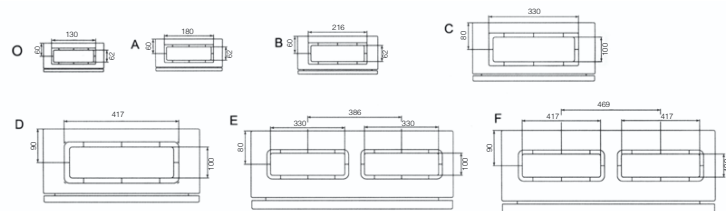

Wall Mount Enclosure



Supply Includes:

- ◆ Enclosure and door mounting plate, Lock system, Gland plate, sealing gasket and Fixing accessories.
- ◆ Surface finish: epoxy polyester powder coating textured finish.
- ◆ Color: RAL 7032 RAL 7035
- ◆ Protection degree: IP 65
- ◆ Against mechanical impacts: IK 10

Material:

- ◆ Enclosure & door: sheet steel 1.2mm till size ST6–820 then 1.5mm.

Mounting Plate:

- ◆ zinc-coated steel 1.5mm till size ST6–820 then 2.0mm

CONFORMITY AND APPROVAL



Selection Table

Model	W	H	D	No.of lock	Gland opening
ST2 215	200	200	150	1	O
ST25 315	250	300	150	1	A
ST3 415	300	400	150	1	B
ST25 320	250	300	200	1	A
ST3 420	300	400	200	1	B
ST4 520	400	500	200	1	B
ST4 620	400	600	200	2	C
ST5 720	500	700	200	2	D
ST6 820	600	800	200	2	D
ST5 725	500	700	250	2	D
ST6 825	600	800	250	2	D

Model	W	H	D	No.of lock	Gland opening
ST6 1025	600	1000	250	2	D
ST8 1025	800	1000	250	2	E
ST8 1225	800	1200	250	2	E
ST5 730	500	700	300	2	D
ST6 830	600	800	300	2	D
ST6 1030	600	1000	300	1	D
ST8 1030	600	1000	300	2	E
ST6 1230	800	1000	300	2	D
ST8 1230	800	1200	300	2	E
ST6 840	600	800	400	2	E
ST8 1240	800	1200	400	2	E

Single Door Wall Mount Enclosure

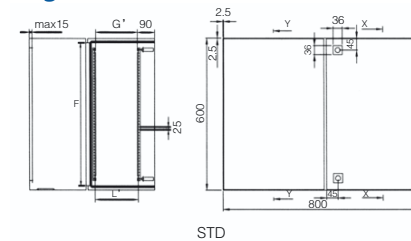

STD

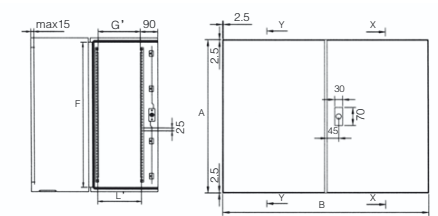

STDD(ROD CONTROL LOCK)

STD is both sides lock, STDD is middle lock

Selection Table

Model	W	H	D	No.of lock	Gland opening
STD8 620	800	600	200	2	E
STD8 630	800	600	300	2	E
STD10 620	1000	600	200	2	E
STD12 630	1200	600	300	2	E
STD10 1025	1000	1000	250	2	F
STD10 1030	1000	1000	300	2	F
STD12 1225	1200	1200	250	2	F
STD10 1230	1000	1200	300	2	F
STD12 1240	1200	1200	400	2	F
STD10 1430	1000	1400	300	2	F
STD12 1430	1200	1400	300	2	F
STD12 1440	1200	1400	400	2	F

Model	W	H	D	No.of lock	Gland opening
STDD8 620	800	600	200	1	E
STDD8 630	800	600	300	1	E
STDD10 620	1000	600	200	1	E
STDD12 630	1200	600	300	1	E
STDD10 1025	1000	1000	250	1	F
STDD10 1030	1000	1000	300	1	F
STDD12 1225	1200	1200	250	1	F
STDD10 1230	1000	1200	300	1	F
STDD12 1240	1200	1200	400	1	F
STDD10 1430	1000	1400	300	1	F
STDD12 1430	1200	1400	300	1	F
STDD12 1440	1200	1400	400	1	F

Wall Mount Enclosure



Plexiglass Door Wall Mount Enclosure

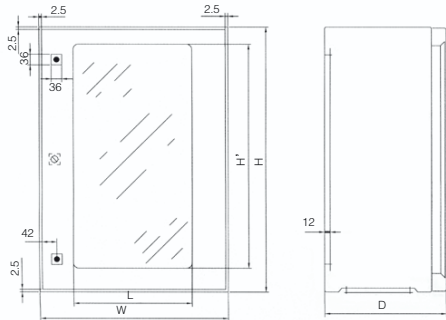

Supply Includes:

- ◆ Enclosure, Plexiglass Door, door, Mounting plate, Lock system, Gland plate, sealing gasket and Fixing accessories.
- ◆ Finish: epoxy polyester powder coating textured finish.
- ◆ Color: RAL 7032 RAL 7035
- ◆ Protection degree: IP 65
- ◆ Against mechanical impacts: IK 10

Material:

- ◆ glass door: Reinforced glass: 4mm.
- ◆ Enclosure door: sheet steel 1.2mm till size ST6-820 then 1.5mm.

Mounting Plate:

- ◆ zinc-coated steel 1.5mm till size ST6-820 then 2.0mm

CONFORMITY AND APPROVAL



Selection Table

Model	W H D	L	Gland opening
STP3 420	300 × 400 × 200	185	315
STP4 420	400 × 400 × 200	285	315
STP3 520	300 × 500 × 250	185	415
STP4 520	400 × 500 × 200	285	415
STP5 520	500 × 500 × 200	385	415
STP4 620	400 × 600 × 200	285	515
STP5 620	500 × 600 × 200	385	515
STP5 720	500 × 700 × 200	385	615
STP6 820	600 × 800 × 200	485	515
STP3 425	300 × 400 × 250	185	215
STP4 525	400 × 500 × 250	285	315
STP4 625	400 × 600 × 250	285	315

Wall Mount Enclosure



Inner door wall mount enclosure(STI)

Supply Includes:

- ◆ Enclosure and door, Mounting plate, Lock system, Inner Door Gland plate, sealing gasket and Fixing accessories.
- ◆ Finish: epoxy polyester powder coating textured finish.
- ◆ Color: RAL 7032 RAL 7035
- ◆ Protection degree: IP 65
- ◆ Against mechanical impacts: IK 10

Enclosure & door:

- ◆ sheet steel 1.2mm till size ST6-820 then 1.5mm.
- ◆ Inner door: sheet steel 1.2mm till size ST6 820 then 1.5mm

Mounting Plate:

- ◆ sheet steel 1.5mm till size ST6-820 then 2.0mm

CONFORMITY AND APPROVAL



Plexiglass door+Inner door wall mount enclosure(STIP)

Supply Includes:

- ◆ Enclosure and door, Mounting plate, Lock system, Inner Door Gland plate, sealing gasket and Fixing accessories.
- ◆ Finish: epoxy polyester powder coating textured finish.
- ◆ Color: RAL 7032 RAL 7035
- ◆ Protection degree: IP 65
- ◆ Against mechanical impacts: IK 10

Enclosure & door:

- ◆ sheet steel 1.2mm till size ST6-820 then 1.5mm.
- ◆ Inner door: sheet steel 1.2mm till size ST6 820 then 1.5mm

Mounting Plate:

- ◆ sheet steel 1.5mm till size ST6-820 then 2.0mm

CONFORMITY AND APPROVAL



The size of cabinet is also suitable to STIP, if you have other requirement for processing method and color, different lock, we can supply series for you.

Selection Table

Model	W H D
STI4 320	400 × 300 × 200
STI4 420	400 × 400 × 200
STI4 520	400 × 500 × 200
STI4 525	400 × 500 × 250
STI4 620	400 × 600 × 200
STI4 625	400 × 600 × 250
STI5 720	500 × 700 × 200
STI5 725	500 × 700 × 250
STI6 420	600 × 400 × 200
STI6 430	600 × 400 × 300
STI6 620	600 × 600 × 200
STI6 630	600 × 800 × 300
STI6 825	600 × 800 × 250
STI6 830	600 × 800 × 300
STI6 1025	600 × 1000 × 250
STI6 1030	600 × 1000 × 300
STI6 1230	600 × 1200 × 300
STI8 1030	800 × 1000 × 300
STI8 1230	800 × 1200 × 300

Selection Table

Model	W H D
STIP4 320	400 × 300 × 200
STIP4 420	400 × 400 × 200
STIP4 520	400 × 500 × 200
STIP4 525	400 × 500 × 250
STIP4 620	400 × 600 × 200
STIP4 625	400 × 600 × 250
STIP5 720	500 × 700 × 200
STIP5 725	500 × 700 × 250
STIP6 420	600 × 400 × 200
STIP6 430	600 × 400 × 300
STIP6 620	600 × 600 × 200
STIP6 630	600 × 800 × 300
STIP6 825	600 × 800 × 250
STIP6 830	600 × 800 × 300
STIP6 1025	600 × 1000 × 250
STIP6 1030	600 × 1000 × 300
STIP6 1230	600 × 1200 × 300
STIP8 1030	800 × 1000 × 300
STIP8 1230	800 × 1200 × 300

JXF Wall Mounting Metal Carbinets



Feature

- ◆ 1.0–1.2mm sheet cold rolled steel both on body and door
- ◆ 1.5mm sheet cold rolled steel on mounting plate
- ◆ Textured surface finish by powder coated
- ◆ Double fold by way of a flashing to prevent water entering.
- ◆ Leak tightness gasket on the door to ensure IP55 Protection degree
- ◆ With door anti-rotation system by assembling bolt easily
- ◆ With one or two double bar locks depending on the size of cabinet.
- ◆ With bolts placed both in the body and door for earth connecting

Specifications

Model	Dimensions(mm) (H×W×D)	Plate Size(mm) (A×B)	Cable entries(mm) (C×D)
OPJ15-2520	250×200×150	200×150	80×130
OPJ15-3025	300×250×150	250×200	80×160
OPJ15-3030	300×300×150	250×250	80×190
OPJ15-4030	400×300×150	350×250	80×190
OPJ15-5040	500×400×150	450×350	80×230
OPJ15-6040	600×400×150	550×350	80×230
OPJ15-6050	600×500×150	550×450	80×330
OPJ15-3025	300×250×200	250×200	100×160
OPJ15-3030	300×300×200	250×250	100×190
OPJ15-4030	400×300×200	350×250	100×190
OPJ15-4040	400×400×200	350×350	100×230
OPJ15-5040	500×400×200	450×350	100×230
OPJ15-6040	600×400×200	550×350	100×230
OPJ15-6050	600×500×200	550×450	100×330
OPJ15-7050	700×500×200	650×450	100×330
OPJ15-8060	800×600×200	750×550	100×430
OPJ15-8080	800×800×200	750×750	100×530

Dimensions(mm)

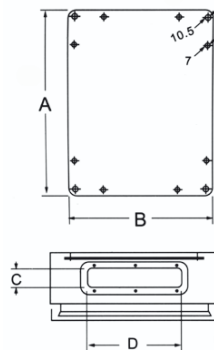

JXF Wall Mounting Metal Carbinets

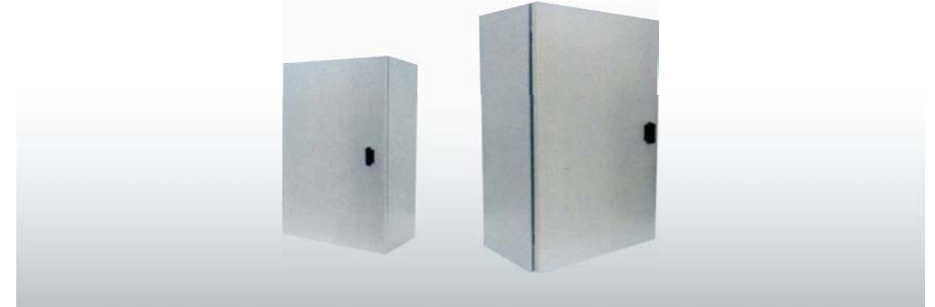

Feature

- ◆ 1.2–1.5mm sheet cold rolled steel both on body and door
- ◆ 1.5mm sheet cold rolled steel on mounting plate
- ◆ Textured surface finish by powder coated
- ◆ Double fold by way of a flashing to prevent water entering.
- ◆ Leak tightness gasket on the door to ensure IP55 Protection degree
- ◆ With door anti-rotation system by assembling bolt easily
- ◆ With one or two double bar locks depending on the size of cabinet.
- ◆ With bolts placed both in the body and door for earth connecting

Specifications

Model	Dimensions(mm) (H×W×D)	Plate Size(mm) (A×B)	Cable entries(mm) (C×D)
OPJ25-5040	500×400×250	450×350	100×230
OPJ25-5050	500×500×250	450×450	100×300
OPJ25-6040	600×400×250	550×350	100×330
OPJ25-6050	600×500×250	550×450	100×330
OPJ25-6060	600×600×250	550×550	100×430
OPJ25-7050	700×500×250	650×450	100×330
OPJ25-8060	800×600×250	750×550	100×430
OPJ25-1006	1000×600×250	950×550	100×430
OPJ25-1008	1000×800×250	950×750	100×530
OPJ30-4060	400×600×300	350×550	100×430
OPJ30-6060	600×600×300	550×550	100×430
OPJ30-8060	800×600×300	750×550	100×430
OPJ30-8080	800×800×300	750×750	100×530
OPJ30-1006	1000×600×300	950×550	100×430
OPJ30-1008	1000×800×300	950×750	100×530
OPJ30-1010	1000×1000×300	950×950	100×630
OPJ30-1208	1200×800×300	1150×750	100×530
OPJ30-1210	1200×1000×300	1150×950	100×630

Dimensions(mm)

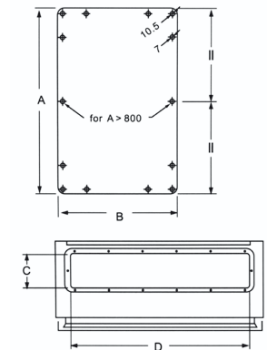

MDB08 3 Phase Metal Distribution Board



Feature

- ◆ 1.5mm sheet cold rolled steel both on base and cover
- ◆ 1.2mm sheet cold rolled steel on door
- ◆ Textured surface finish by powder coated
- ◆ With neutral & earth link and loading holder fixed inside
- ◆ With preformed cable and copper bus-bar supplied
- ◆ With bolt and nuts supplied for earth connecting
- ◆ Rated voltage 415V AC 50/60Hz
- ◆ Rated bus-bar capacity not exceeding 250A
- ◆ Maximum loading 24 way (or 8 way x 3 phase)

Dimensions (mm)

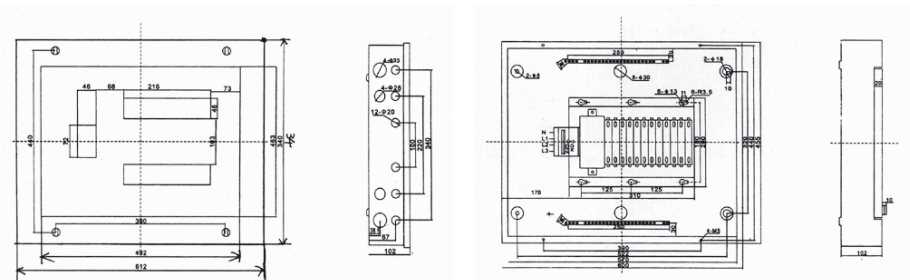

MED Metal Modular Enclosure



Feature

- ◆ 1.0mm sheet cold rolled steel
- ◆ Smooth surface finish by powder coated
- ◆ With terminal link and rail fixed inside the box
- ◆ With bolt and nuts supplied for earth connecting
- ◆ Maximum rating 125A

Specifications

Model	W	H	D	A	B	C	E
MED-2WAY	77	145	61	36	47	37	90
MED-3WAY	109	175	61	54	47	67	114
MED-4WAY	113	225	61	72	47	72	166

Dimensions(mm)

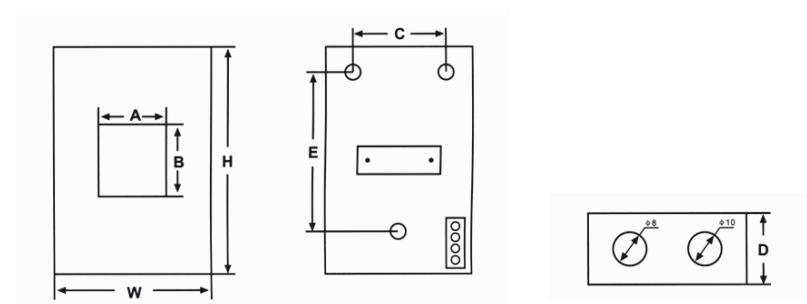

Accessories For Wall Mount Enclosure



General

MDST Modular kit assembly for modular switch gear, with adjustable symmetrical distance between sections of 35mm and cove plate from 40 to 85mm depending on user requirements.

Construction:
 Frame in 1.2mm sheet steel.
 Front panel in 1.2mm sheet steel.
 Finish: OPEN standard cycle thermosetting epoxy polyester powder coating.
 Color RAL 7032 RAL7035 textured finish.

Supply Includes:
 Frame:
 Front panel with modular slot complete with mounting accessories and captive screws
 Zinc passivated DIN rail(once per slot).
 Accessories to mount in the box.

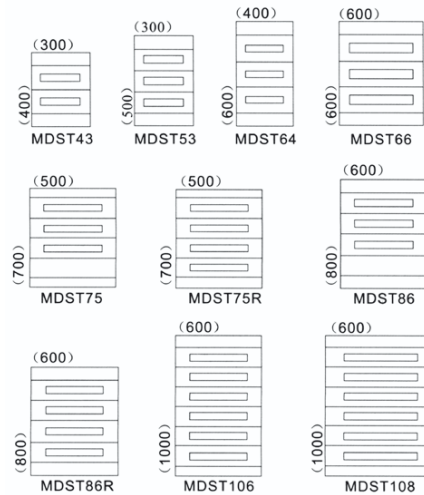

Selection Table

Door(mm) H W	Model	No.of breakers	Breakers qty PCS	No.of rows
400 300	MDST43	2rows x 10P	20	2
500 400	MDST53	3rows x 15P	45	3
600 400	MDST64	3rows x 15P	45	3
600 600	MDST66	3rows x 26P	78	3
700 500	MDST75	3rows x 21P	63	4
700 500	MDST75R	4rows x 21P	84	4
800 600	MDST86	3rows x 26P	78	4
800 600	MDST86R	4rows x 26P	104	4
1000 600	MDST106	6rows x 26P	158	6
1000 800	MDST108	6rows x 38P	228	6

Accessories For Wall Mount Enclosure



Metal Lock

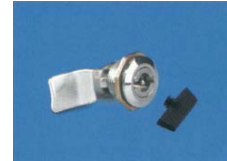

LK-5



LK-5-A

MS820

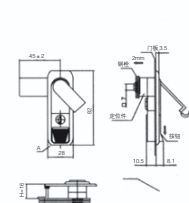
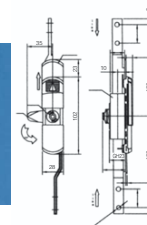

MS738



Locks



ST Plinth

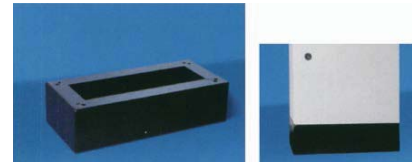

100mm high Plinth can be used for ST boxes.
 Material: sheet steel Color: RAL6022

Model	Cabinet Size(W x D)	Model	Cabinet Size(W x D)
TT42	400 x 200	TT43	400 x 300
TT52	500 x 200	TT53	500 x 300
TT62	600 x 200	TT63	600 x 300
TT82	800 x 200	TT83	800 x 300
TT102	1000 x 200	TT103	1000 x 300
TT122	1200 x 200	TT123	1200 x 300

Earthing wire

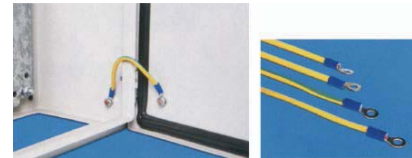

Model	S(mm ²)	Length(mm)	Diameter of rings(mm)
OP-CM6130	6	130	6.4
OP-CM6160	6	160	6.4
OP-CM6168	6	160	8.3
OP-CM1025	10	250	6.4
OP-CM2535	25	350	8.3

Accessories For Wall Mount Enclosure

◆ Canopy

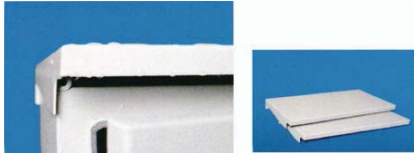

CODE		WIDTH	DEPTH
MOD.	ART		
TT1	04	400	200
TT2	04	400	250
TT1	05	500	200
TT2	05	500	250
TT1	06	600	250
TT2	06	600	300
TT2	08	800	300

Recommended for outdoor installation. Manufactured in 1.2mm sheet steel.

Surface finish:

OPEN standard cycle thermosetting epoxy polyester powder coating in textured for outdoor installation we suggest a specific painting.

◆ Crosspiece for door



CODE		WIDTH
MOD.	ART	BOX
WC	001	300
WC	002	400
WC	003	500
WC	004	600
WC	005	800

To be fixed on the vertical rail of the door to simplify fixing of cable ducts. Manufactured in 1.2mm sheet steel. Zinc plated passivated with 4.2mm diameter holes punched in 25mm pinch pattern. Packs of 1 piece with fixing material.

◆ WA 060



Door stop

Holds the door at 90° to avoid accidental closing. Manufactured in 2mm and 3mm sheet steel zinc plated passivated Can be used on st boxes till size ST6 820. Pack of 1 piece with fixing material.

◆ WA 070



Door stop

Holds the door at 90° to avoid accidental closing. Manufactured in 2mm and 3mm sheet steel zinc plated passivated Can be used on st boxes from ST6 820. Pack of 1 piece with fixing material

◆ Wall mounting brackets WC010



Manufactured in 4mm sheet steel zinc plated passivated. Pack of 4 pcs with fixing material.

Accessories For Wall Mount Enclosure



Louver Plates



To be fitted on any surface of the enclosure for internal ventilation. Color RAL-7032 textured.

ref.	A	B	C	D	E	F
GP-1	158	78	65	100	-	-
GP-2	208	89	72	80	190	-
GP-3	244	90	72	80	226	-
GP-4	359	129	114	300	344	100
GP-5	445	148	130	300	427	100
GP-6	259	79	65	200	-	100
GP-7	158	90	72	80	140	-
GP-8	345	148	130	200	327	100
GP-9	558	129	116	500	454	100

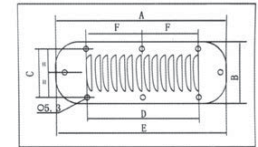

WI02 45° brackets

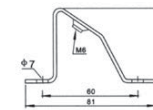

WL 02 brackets can be used to slope the DIN RAILS into 45, 1 pack of 20 pieces.

WS02 brackets

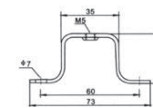

WS 02 brackets can be used to upraise the DIN RAILS, 1 pack of 20 pieces.

WA 080 upright post fixing



Upright post fixing

WA 080 upright post fixing can be used to fix the ST boxes onto upright posts easily, the width of the boxes should be no more than 600mm.

Material: sheet steel, galvanized, stainless steel.

Supply includes:

4pcs nuts and bolts

Packing: 1 set per pack



Small Terminal Box TL Series



TL Series Small Terminal Box

- ◆ Supply Include: Enclosure & cover (sheet steel 1.2mm), sealing gasket and fixing accessories,
- ◆ Paint finish: epoxy polyester powder coating textured finish
- ◆ Color: RAL7032 RAL7035
- ◆ Protection degree: IP66
- ◆ Against mechanical impacts: IK10

Model	W H D	Mounting plate
TL15158	150 × 150 × 80	TL1515
TL151512	150 × 150 × 120	TL1515
TL20158	200 × 150 × 80	TL2015
TL201512	200 × 150 × 120	TL2015
TL20208	200 × 200 × 80	TL2020
TL202012	200 × 200 × 120	TL2020
TL30158	300 × 150 × 80	TL3015
TL301512	300 × 150 × 120	TL3015
TL30208	300 × 200 × 80	TL3020
TL302012	300 × 200 × 120	TL3020
TL303012	300 × 300 × 120	TL3030
TL401512	400 × 150 × 120	TL4015
TL40208	400 × 200 × 80	T14020
TL402012	400 × 200 × 120	TL4020
TL403012	400 × 300 × 120	TL4030
T1404012	400 × 400 × 120	T14040
TL502012	500 × 200 × 120	TL5020
TL503012	500 × 300 × 120	TL5030
TL60208	600 × 200 × 80	TL6020
TL602012	600 × 200 × 120	TL6020
TL603012	600 × 300 × 120	TL6030
TL604012	600 × 400 × 120	TL6040
TL802012	800 × 200 × 120	TL8020
TL804012	800 × 400 × 120	T18040

Model	W H D	Mounting plate
TL301512-G	300 × 150 × 120	TL3015
TL302012-G	300 × 200 × 120	TL3020
TL303012-G	300 × 300 × 120	TL3030
TL402012-G	400 × 200 × 120	TL4020
TL404012-G	400 × 400 × 120	TL4040
TL502012-G	500 × 200 × 120	TL5020
TL503012-G	500 × 300 × 120	TL5030
TL602012-G	600 × 200 × 120	TL6020
TL603012-G	600 × 300 × 120	TL6030
TL604012-G	600 × 400 × 120	TL6040
TL802012-G	800 × 200 × 120	TL8020
TL804012-G	800 × 400 × 120	T18040

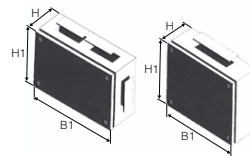

With gland hole

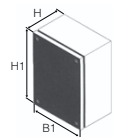

No gland hole

Small Terminal Box TB TBS Series



TB series 180° hinges with lock system

- ◆ Supply Include: Enclosure with gland holes, cover with sealing gasket and fixing accessories, lock system
- ◆ Paint finish: epoxy polyester powder coating textured finish.
- ◆ Color: RAL7032 RAL7035
- ◆ Protection degree: IP66
- ◆ Against mechanical impacts: Ik10

Model	W H D	Mounting plate
TB15158	150 × 150 × 80	TB1515
TB15308	150 × 300 × 80	TB1530
TB20208	200 × 200 × 80	TB2020
TB20308	200 × 300 × 80	TB2030
TB20408	200 × 400 × 80	TB2040
TB151512	150 × 150 × 120	TB1515
TB153012	150 × 300 × 120	TB1530
TB202012	200 × 200 × 120	TB2020
TB203012	200 × 300 × 120	TB2030
TB204012	200 × 400 × 120	TB2040
TB205012	200 × 500 × 120	TB2050
TB303012	300 × 300 × 120	TB3030
TB304012	300 × 400 × 120	TB3040
TB3040155	300 × 400 × 155	TB3040
TB3060155	300 × 600 × 155	TB3060
TB3080155	300 × 800 × 155	TB3080

TBS series 180° hinges with hinges

- ◆ Supply Include: Enclosure with gland holes, cover with sealing gasket and fixing accessories
- ◆ Paint finish: epoxy polyester powder coating textured finish.
- ◆ Color: RAL7032 RAL7035
- ◆ Protection degree: IP66
- ◆ Against mechanical impacts: Ik10

Model	W H D	Mounting plate
TBS15158	150 × 150 × 80	TB1515
TBS15308	150 × 300 × 80	TB1530
TBS20208	200 × 200 × 80	TB2020
TBS20308	200 × 300 × 80	TB2030
TBS20408	200 × 400 × 80	TB2040
TBS151512	150 × 150 × 120	TB1515
TBS153012	150 × 300 × 120	TB1530
TBS202012	200 × 200 × 120	TB2020
TBS203012	200 × 300 × 120	TB2030
TBS204012	200 × 400 × 120	TB2040
TBS205012	200 × 500 × 120	TB2050
TBS303012	300 × 300 × 120	TB3030
TBS304012	300 × 400 × 120	TB3040
TBS3040155	300 × 400 × 155	TB3040
TBS3060155	300 × 600 × 155	TB3060
TBS3080155	300 × 800 × 155	TB3080



Wall mount bracket: WTC 010 For the TB,TL,TBS,TL-G Package: 4pcs/set



Mounting plate: zinc coated in 1.5mm sheet. For the box series TB,TL,TBS,TL-G Package: 1 pc

MCU Series Of Metal Consumer Unit



Features

- ◆ 1.0mm sheet cold rolled steel both on body base
- ◆ Textured surface finish by powder coated
- ◆ With transparent cover made by PC material
- ◆ With terminal link and rail fixed inside the box
- ◆ With flexible wires or cables and bus-bar supplied
- ◆ With bolt and nuts supplied for earth connecting
- ◆ Fitted with isolator main switch or RCCB and MCBS.

Specifications

Model	Specifications	Description
MCU-4	4WAY	Main switch or RCCB and 2 outgoing ways
MCU-6	6WAY	Main switch or RCCB and 4 outgoing ways
MCU-8	8WAY	Main switch or RCCB and 6 outgoing ways
MCU-0	10WAY	Main switch or RCCB and 8 outgoing ways
MCU-14	14WAY	Main switch or RCCB and 12 outgoing ways

Dimensions(mm)

Model	L1	L2	L3	W1	W2	W3	H1	H2
MCU-4	127	120	76	185	178	128	101	80
MCU-6	163	156	100	185	178	128	101	80
MCU-8	199	192	140	185	178	128	101	80
MCU-0	235	228	175	185	178	128	101	80
MCU-14	307	300	250	185	178	128	101	80

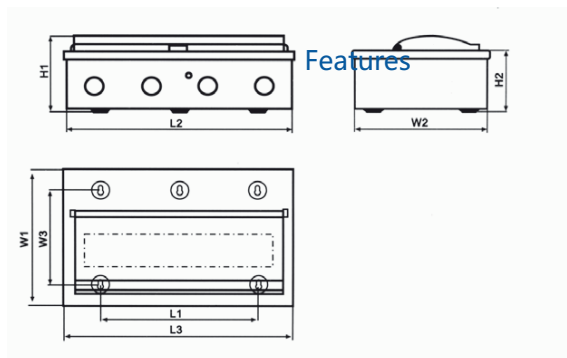

Features

TML Series Of Distribution Box

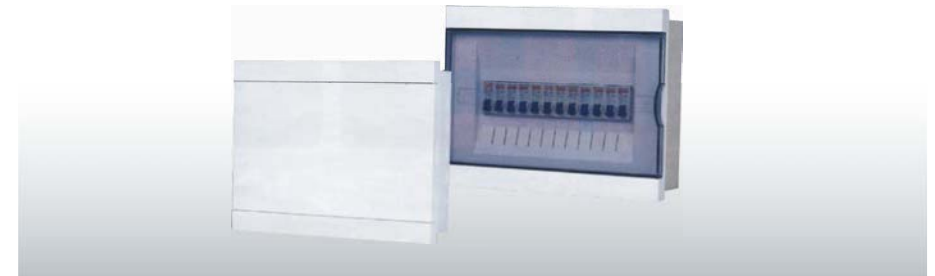

General

TML Series lighting box is attractive and durable, safe and reliable, widely used in various places such as factory, mansion, residence, shopping center and so on.

Features

- ◆ Meet the IEC, GB, JB product standards, and enhanced fire-retardant materials are used to ensure safety.
- ◆ Simple and smooth appearance, light door opening and closing mode, applicable to the home application.
- ◆ Provide 6-24 circuit, a plurality of specifications, high-quality matching miniature circuit breaker, which can meet various needs.

Features

- ◆ Rated current: 63 (A)
- ◆ Short-circuit making current: 10 (KA)
- ◆ Shell protection grade: IP40 Shell material: ABS polymeric carbon
- ◆ Color: White

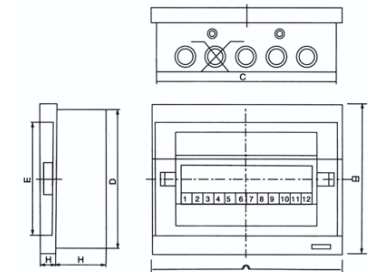

Type	Specification	Dimensions(mm)					
		A	B	C	D	E	H
6 Ways (flush)	ABX0-6R	215	210	195	190	175	82
8 Ways (flush)	ABX0-8R	250	230	230	210	177	82
12 Ways (flush)	ABX0-12R	320	250	300	230	187	82
16 Ways (flush)	ABX0-16R	390	250	370	230	187	82
20 Ways (flush)	ABX0-20R	460	250	440	230	187	82
24 Ways (flush)	ABX0-24R	320	400	300	380	150	90
6 Ways (surface)	ABX0-6	215	210	310	205	157	100
8 Ways (surface)	ABX0-8	250	230	245	225	177	100
12 Ways (surface)	ABX0-12	320	250	315	245	187	100
16 Ways (surface)	ABX0-16	390	250	385	245	187	100
20 Ways (surface)	ABX0-20	460	250	455	245	187	100
24 Ways (surface)	ABX0-24	320	400	315	395	150	100

MCB BOX

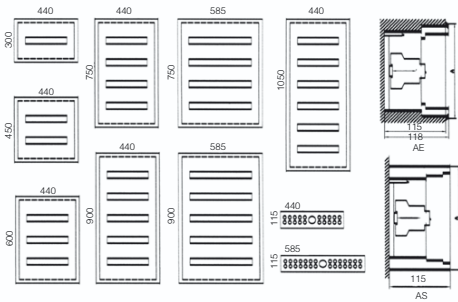

Features

- ◆ AS & AE series boxes are OPEN specially designs for MCBs. This kind of surface & flush mounting boxes can assemble 16P &c 24P MCBs each row, or adjust by your own.
- ◆ Material: Sheet steel 1.2mm
- ◆ Protection degree: IP41
- ◆ Surface finish: epoxy polyester powder coating textured finish
- ◆ Color: RAL 7035

Selection Table

DOOR(mm)		Surface type	H	W	Surface type	1 ROW	NO. of breakers
H	W						
300	440	AS116	325	465	AE116	1	× 16P
450	440	AS216	475	465	AE216	2	× 16P
600	440	AS316	625	465	AE316	3	× 16P
750	440	AS416	775	465	AE416	4	× 16P
900	440	AS516	925	465	AE516	5	× 16P
1050	400	AS616	1075	465	AE616	6	× 16P
750	585	AS716	775	610	AE716	4	× 24P
800	585	AS816	925	610	AE816	5	× 24P

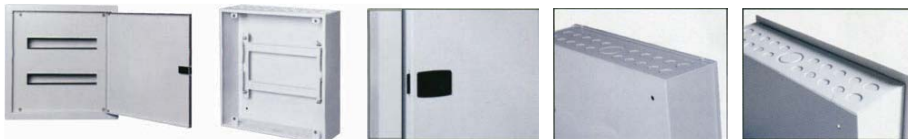

Telephone Enclosure And Gland Box



Telephone Enclosure

- ◆ OPEN telephone enclosures are designed to accommodate telephone connectors and used for domestic and commercial application.
- ◆ Material: sheet steel 1.2mm, mounting plate: 1.5mm
- ◆ Finish: epoxy polyester powder coating textured finish
- ◆ Color: RAL7035

Gland box

- ◆ GB series box can be used as the gland box of the ST series enclosures.
- ◆ Material: sheet steel 1.2mm
- ◆ Surface finish: epoxy polyester powder coating textured finish
- ◆ Color: RAL 7032 RAL 7035

Designed for indoor (IP41/NEMA1) application Flush and surface mounted designs

Description	Height	Width	Depth	Connection pairs	CAT.NO
Surface Type	230	230	100	10TO40	TE2323
Flush Type	230	230	100	10TO60	TEF2323
Surface Type	300	330	100	10TO70	TE3033
Flush Type	300	330	100	10TO80	ETF3033
Surface Type	370	520	100	10TO140	TE3752
Flush Type	370	520	100	10TO160	TEF3752
Surface Type	520	620	100	10TO420	TE5262

Model	Size		
	H	W	D
GB432	300	400	200
GB532	300	500	200
GB632	300	600	200
GB8325	300	800	250
GB4252	250	400	200
GB5252	250	500	200
GB6252	250	600	200
GB82525	250	800	250
GB422	200	400	200
GB522	200	500	200
GB1033	300	1000	300

Stainless Steel Box with Single Blank Door



Characteristics

STRUCTURE

- ◆ Rails are made up of unique closed profile manufactured from 15/10 AISI 304L stainless steel.
- ◆ The frame corners are manufactured with orthogonal joints in AISI 304L stainless steel, laser welded to the rails.
- ◆ Only 8 high resistance screws in stainless steel are necessary to mount the structure, while two position pins allow the easy mounting of the two parts of the joint.
- ◆ Doors manufactured from 20/10 AISI 304L (AISI 316L on request) satin stainless steel with tubular stiffening frame.
- ◆ Hinges are made in zinc alloy, chrome plated, open 180° (hinges manufactured from AISI 316L stainless steel on request).
- ◆ Rear panel manufactured from 15/10 AISI 304L (AISI 316L on request) satin stainless steel.
- ◆ Roof manufactured from 15/10 AISI 304L (AISI 316L on request) satin stainless steel.
- ◆ Bottom manufactured from 15/10 AISI 304L (AISI 316L on request) satin stainless steel.

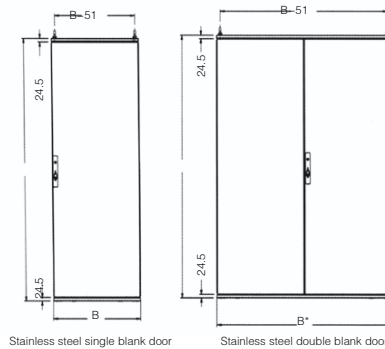

Stainless steel single blank door

Stainless steel double blank door

Model	W	H	D	No. of lock
AR9X186/4	600	1800	400	1
AR9X186/5	600	1800	500	1
AR9X206/5	600	2000	500	1
AR9X206/6	600	2000	600	1
AR9X188/4	800	1800	400	1
AR9X188/5	800	1800	500	1
AR9X208/5	800	2000	500	1
AR9X208/6	800	2000	600	1

Model	W	H	D	No. of lock
AR9X1810/5	1000	1800	500	1
AR9X1810/6	1000	1800	600	1
AR9X2010/5	1000	2000	500	1
AR9X2010/6	1000	2000	600	1
AR9X1812/4	1200	1800	400	1
AR9X1812/5	1200	1800	500	1
AR9X2012/5	1200	2000	500	1
AR9X2012/6	1200	2000	600	1

Delivery

- ◆ Structure
- ◆ Door complete with 3mm double bar locking system
- ◆ Rear panel
- ◆ Removable roof
- ◆ Bottom with removable cable entry.

CONFORMITY AND APPROVAL



Stainless Steel With Glazed Door



Characteristics

STRUCTURE

- ◆ Rails are made up of unique closed profile manufactured from 15/10 AISI 304L stainless steel.
- ◆ The frame corners are manufactured with orthogonal joints in AISI 304L stainless steel, laser welded to the rails.
- ◆ Only 8 high resistance screws in stainless steel are necessary to mount the structure, while two position pins allow the easy mounting of the two parts of the joint.
- ◆ Door manufactured in 20/10 AISI 304L (AISI 316L on request) satin stainless steel with stiffening frame and plexiglas viewing window.
- ◆ Hinges are made in zinc alloy, chrome plated (hinges manufactured from AISI 316L stainless steel on request).
- ◆ Rear panel manufactured from 15/10 AISI 304L (AISI 316L on request) satin stainless steel
- ◆ Roof manufactured from 15/10 AISI 304L (AISI 316L on request) satin stainless steel.
- ◆ Bottom manufactured from 15/10 AISI 304L (AISI 316L on request) satin stainless steel.

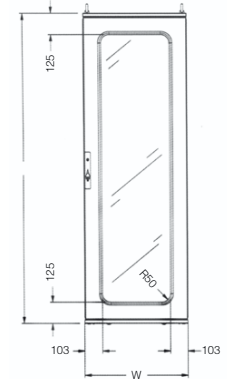

Delivery

- ◆ Structure
- ◆ Door with plexiglas complete with 3mm double bar locking system
- ◆ Hinges in zinc alloy, chrome plated
- ◆ Rear panel
- ◆ Removable roof
- ◆ Bottom with removable cable entry.

Model	W	H	D	No. of lock
AR9XP186/4	600	1800	400	1
AR9XP186/5	600	1800	500	1
AR9XP206/5	600	2000	500	1
AR9XP206/6	600	2000	600	1
AR9XP188/4	800	1800	400	1
AR9XP188/5	800	1800	500	1
AR9XP208/5	800	2000	500	1
AR9XP208/6	800	2000	600	1
AR9XP1810/5	1000	1800	500	1
AR9XP1810/6	1000	1800	600	1
AR9XP2010/5	1000	2000	500	1
AR9XP2010/6	1000	2000	600	1

Protection Ratings

- ◆ IP 66 complying with IEC EN62208; EN60529
- ◆ NEMA 12 complying with UL508A; UI50
- ◆ Impact resistance IK10 complying with IEC EN62208; EN50102.

Stainless Steel Box



Characteristics

- ◆ Structure manufactured from 15/10 AISI 304L material with removable rear panel.
- ◆ Door manufactured from 20/10 AISI 304L material with stiffening frame.
- ◆ Item available in AISI 316L on request.
- ◆ Hinges in zinc alloy, chrome plated.

CONFORMITY AND APPROVAL



Model (with mounting plate)	Dimension(mm) W H D	Number of door
AR8 1010/3	1000 × 1000 × 300	1
AR8 128/3	800 × 1200 × 300	1
AR8 146/4	600 × 1400 × 400	1
AR8 148/3	800 × 1400 × 300	1
AR8 148/4	600 × 1600 × 400	1
AR8 166/4	800 × 1600 × 400	1
AR8 168/3	800 × 1600 × 300	1
AR8 1610/3	800 × 1600 × 400	1
AR8 186/3	1000 × 1600 × 300	1
AR8 186/5	600 × 1800 × 300	1
AR8 188/3	600 × 1800 × 500	1
AR8 188/4	800 × 1800 × 400	1

Delivery

- ◆ Cabinet structure.
- ◆ Door complete with 3mm double bar locking system adjustable cable entry.
- ◆ Mounting plate manufactured from 25/10 sheet steel.

Protection Ratings

- ◆ IP 54 complying with IEC EN62208; EN60529
- ◆ NEMA 12 complying with UL508A; UI50
- ◆ Impact resistance IK10 complying with IEC EN62208; EN50102.

Model (with mounting plate)	Dimension(mm) W H D	Number of door
AR8 188/8	800 × 1800 × 800	1
AR8 1810/4	1000 × 1800 × 400	1
AR8 1810/5D	1200 × 1800 × 500	2
AR81816/4D	1600 × 1800 × 400	2
AR8 206/4	600 × 2000 × 400	1
AR8 206/5	600 × 2000 × 500	1
AR8 208/4	800 × 2000 × 400	1
AR8 208/6	800 × 2000 × 600	1
AR8 2010/4	1000 × 2000 × 400	1
AR8 2012/4D	1200 × 2000 × 400	2
AR8 2012/6D	1200 × 2000 × 600	2
AR8 2016/4D	1600 × 2000 × 400	2

Stainless Steel Box



Characteristics

- ◆ Boxes and door manufactured from 12/10 AISI 304L stainless steel (AISI 316L on request).
- ◆ Lid fixing with stainless steel screws.
- ◆ Holes for fixing the hinges.

Protection Ratings

- ◆ IP 66 complying with IEC EN62208; EN60529
- ◆ NEMA 4X complying with UL508A; UI50
- ◆ Impact resistance IK10 complying with IEC EN62208; EN50102.

CONFORMITY AND APPROVAL



Model	W H D
TLX15158	150 × 150 × 80
TLX151512	150 × 150 × 120
TLX201512	200 × 150 × 120
TLX20208	200 × 200 × 80
TLX30158	300 × 150 × 80
TLX301512	300 × 150 × 120

Model	W H D
TLX30208	300 × 200 × 80
TLX302012	300 × 200 × 120
TLX401512	400 × 150 × 120
TLX40208	400 × 200 × 80
TLX403012	400 × 300 × 120
TLX404012	400 × 400 × 120

Model	W H D
TLX502012	500 × 200 × 120
TLX503012	500 × 300 × 120
TLX602012	600 × 200 × 120
TLX603012	600 × 300 × 120
TLX802012	800 × 200 × 120
TLX804012	800 × 400 × 120

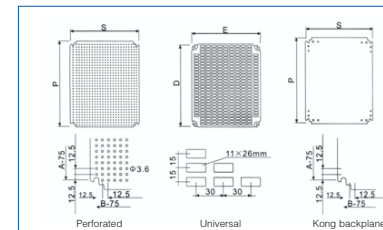
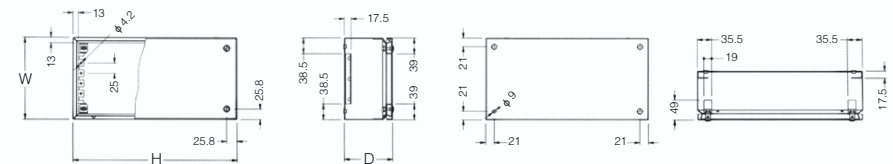

Mounting Plate To Be Ordered Separately

Model	BOX DIMENSIONS		PLATE DIMENSIONS	
	W	H	W	H
SDPA-11	150	150	140	140
SDPA-22	200	200	176	170
SDPA-32	300	200	276	170
SDPA-33	300	300	276	270
SDPA-42	400	200	376	170

Stainless Steel Box With Single Blank Door



Characteristics

- ◆ Enclosure and door manufactured from AISI 304L 15/10 sheet steel (AISI 316L on request).
- ◆ Flat mounting plate manufactured from 25/10 sheet steel.
- ◆ Hinge in stainless steel.

Protection Ratings

- ◆ IP66 complying with IEC EN62208; EN60529
- ◆ NEMA 4X complying with UL508A; UL50
- ◆ Impact resistance IK10 complying with IEC EN62208; EN50102.

Delivery

Box complete with:

- ◆ Mounting plate
- ◆ Locking system body in zinc alloy and lever in stainless steel with 3 mm double bar key
- ◆ Package with hardware for earth connection and screws for mounting plate.

CONFORMITY AND APPROVAL

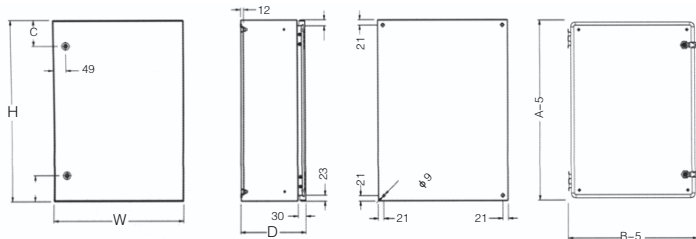

Stainless Steel Box With Single Blank Door

Model	W H D	NO.of lock	Model	W H D	NO.of lock
STX2-315	200 × 300 × 150	1	STX6-620	600 × 600 × 200	2
STX3-415	300 × 400 × 150	1	STX6-625	600 × 600 × 250	2
STX3-420	300 × 400 × 200	1	STX6-630	600 × 600 × 300	2
STX4-315	400 × 300 × 150	1	STX6-820	600 × 800 × 200	2
STX4-420	400 × 400 × 200	1	STX6-825	600 × 800 × 250	2
STX4-520	400 × 500 × 200	1	STX6-830	600 × 800 × 300	2
STX4-620	400 × 600 × 200	2	STX6-1230	600 × 1200 × 300	2
STX5-520	500 × 500 × 200	2	STX8-830	800 × 800 × 300	2
STX5-725	500 × 700 × 100	2	STX8-1030	800 × 1000 × 300	2
STX6-420	600 × 400 × 200	2	STX8-1230	800 × 1200 × 300	2

Stainless Steel Box With Glazed Door-STPX



Characteristics

- ◆ Enclosure manufactured from 15/10 AISI 304L material (AISI 316L on request).
- ◆ Door manufactured from 15/10 AISI 304L material (AISI 316L on request) with plexiglas viewing window.
- ◆ Flat mounting plate manufactured from 25/10 sheet steel.
- ◆ Hinges in stainless steel.

Delivery

Box complete with:

- ◆ Mounting plate
- ◆ Gland plate with sealing gasket
- ◆ Locking system body in zinc alloy
- ◆ Lever in stainless steel with 3 mm double bar key
- ◆ Package with hardware for earth connection and screws for mounting plate

CONFORMITY AND APPROVAL

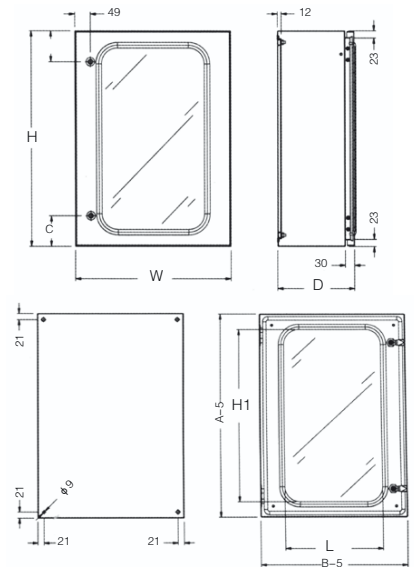

Protection Ratings

- ◆ IP66 complying with IEC EN62208; EN60529
- ◆ NEMA 4X complying with UL508A; UL50
- ◆ Impact resistance IK10 complying with IEC EN62208; EN50102.

Stainless Steel Box With Glazed Door

Model	W H D	No.of lock
STXP3420	300 × 400 × 200	1/2
STXP4520	400 × 500 × 200	1/2
STXP4620	400 × 600 × 200	1/2
STXP5725	500 × 700 × 250	1/2
STXP6820	600 × 800 × 200	1/2
STXP6825	600 × 800 × 250	1/2

Aluminum Enclosure



Characteristics

Enclosures are made of Aluminums, Plastic and Glass-fiber reinforced polyester, as well as machine control and suspension systems protect sensitive electronics in a wide range of industrial applications.

Standard supply :

Aluminum box PUR Seal Stainless steel screws, M4 screws

Specification:

- ◆ Material: ALS 12 DIN1725 Standard
- ◆ Protection Degree: IP66 EN60529 standard
- ◆ Resistance to Impact: >7Joule EN50014 Standard
- ◆ Temperature Range: -40°C to 90°C
- ◆ Paint Finish: Epoxy polyester powder coating
- ◆ Color: RAL7038

CONFORMITY AND APPROVAL



Selection Table

Model	W	H	D
FA1	64	58	35
FA2	120	80	55
FA2-1	120	80	55
FA3	188	120	75
FA5	222	145	55
FA6	222	145	75
FA7	111	64	37
FA12	200	120	75
FA18	80	80	64
FA20	175	65	55
FA24	115	65	55
FA26	160	100	65
FA34	115	90	60

Model	W	H	D
FA60	120	120	82
FA61	160	160	70
FA62	60	160	90
FA63	240	160	70
FA65	240	160	90
FA66	260	185	96
FA67	260	185	120
FA68	295	210	100
FA69	295	210	130
FA70	330	230	120
FA71	330	230	160
FA72	380	260	130
FA73	380	260	165

OEM And ODM



Other specific requested in size, technical processing, color and locking system can provide according to your requirement.

Our technician establish strict regular to supervise the drawing. Ensure your drawing including original drawing, modified drawing can't be obtained by others.

Remark: DBS series and DBB series can be matched freely.

Industrial Cabinets perfect solution tailored just for you!